

Department of Code Compliance
Executives & Management

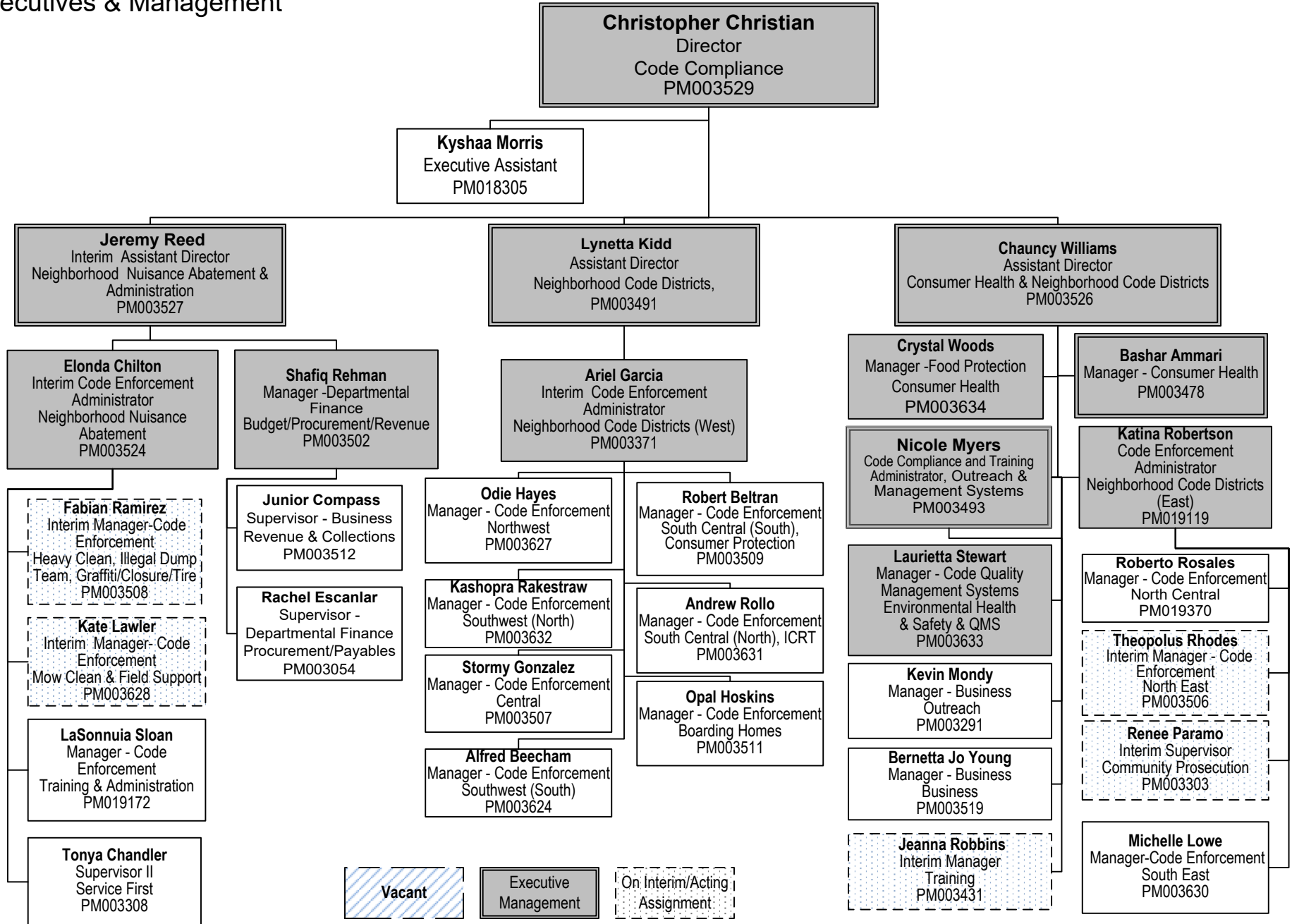

Department of Code Compliance
 Consumer Health,
 Mosquito Abatement, and Neighborhood Code Districts (West)
 7901 Goforth Road

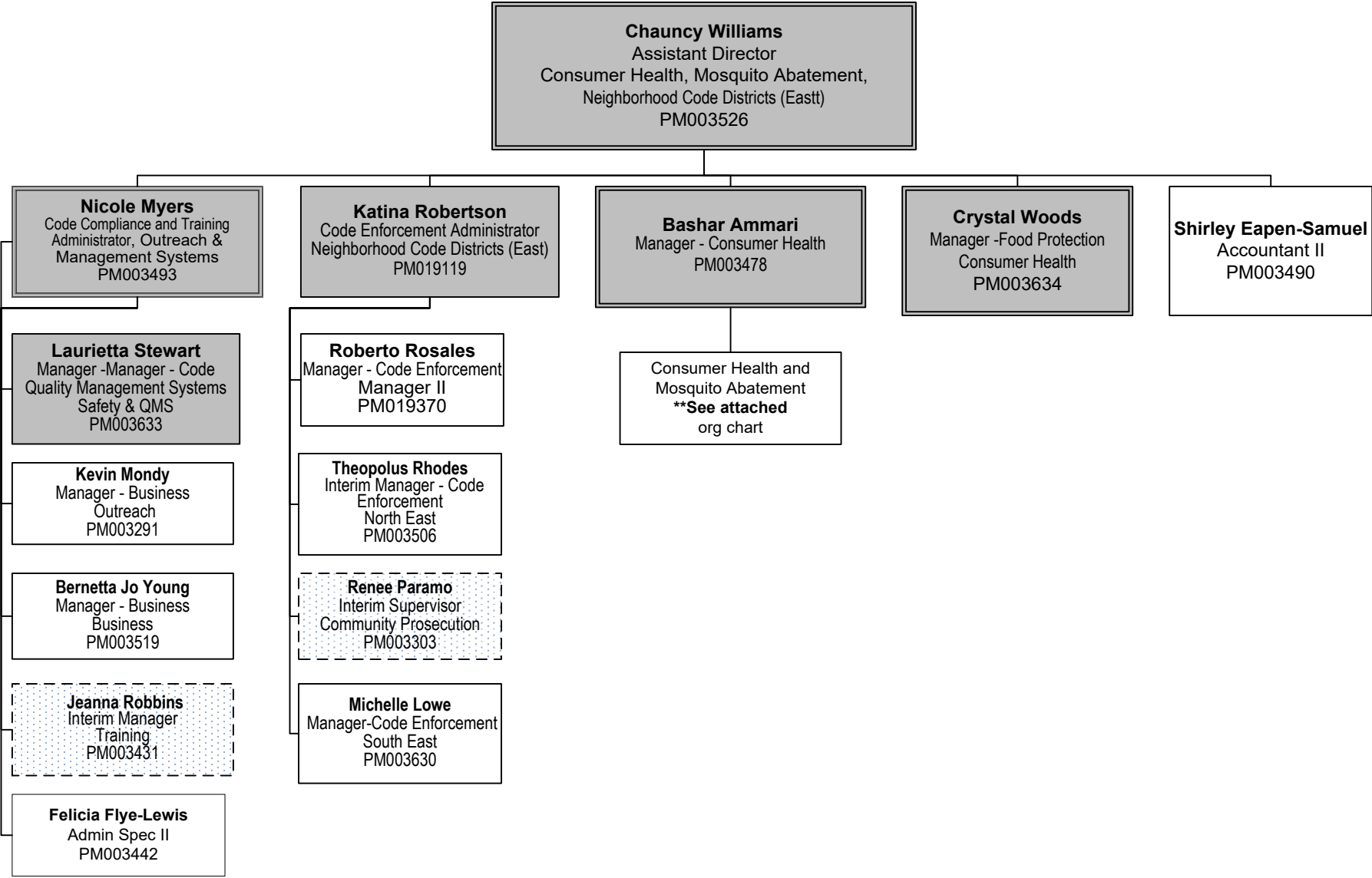

Department of Code Compliance
Training, Marketing and Outreach,
and Management Systems, EH&S, and QMS
3112 Canton Street, 2nd Floor

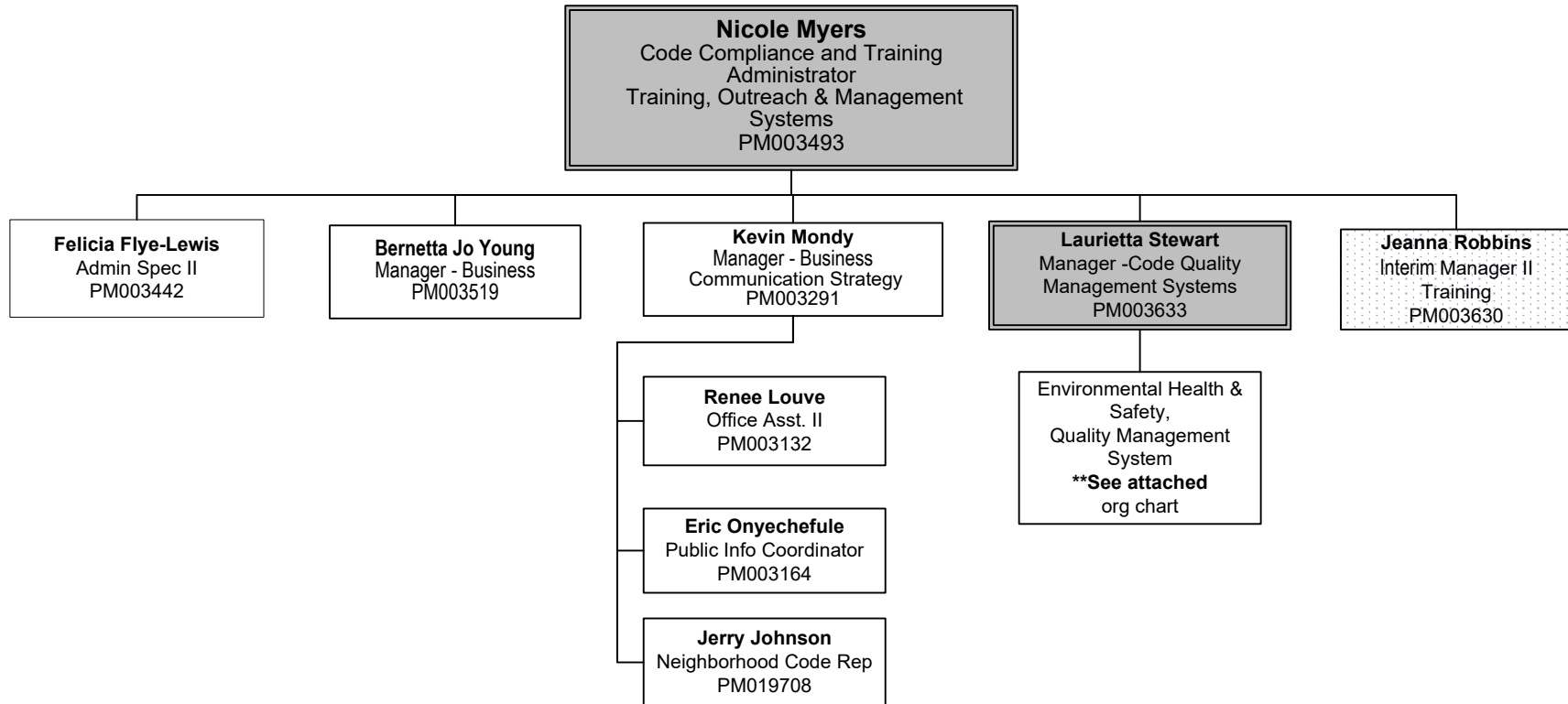

Department of Code Compliance
Administration, Budget, Procurement/Payables
Revenue & Collections
(3452)
3112 Canton Street, 1st Floor

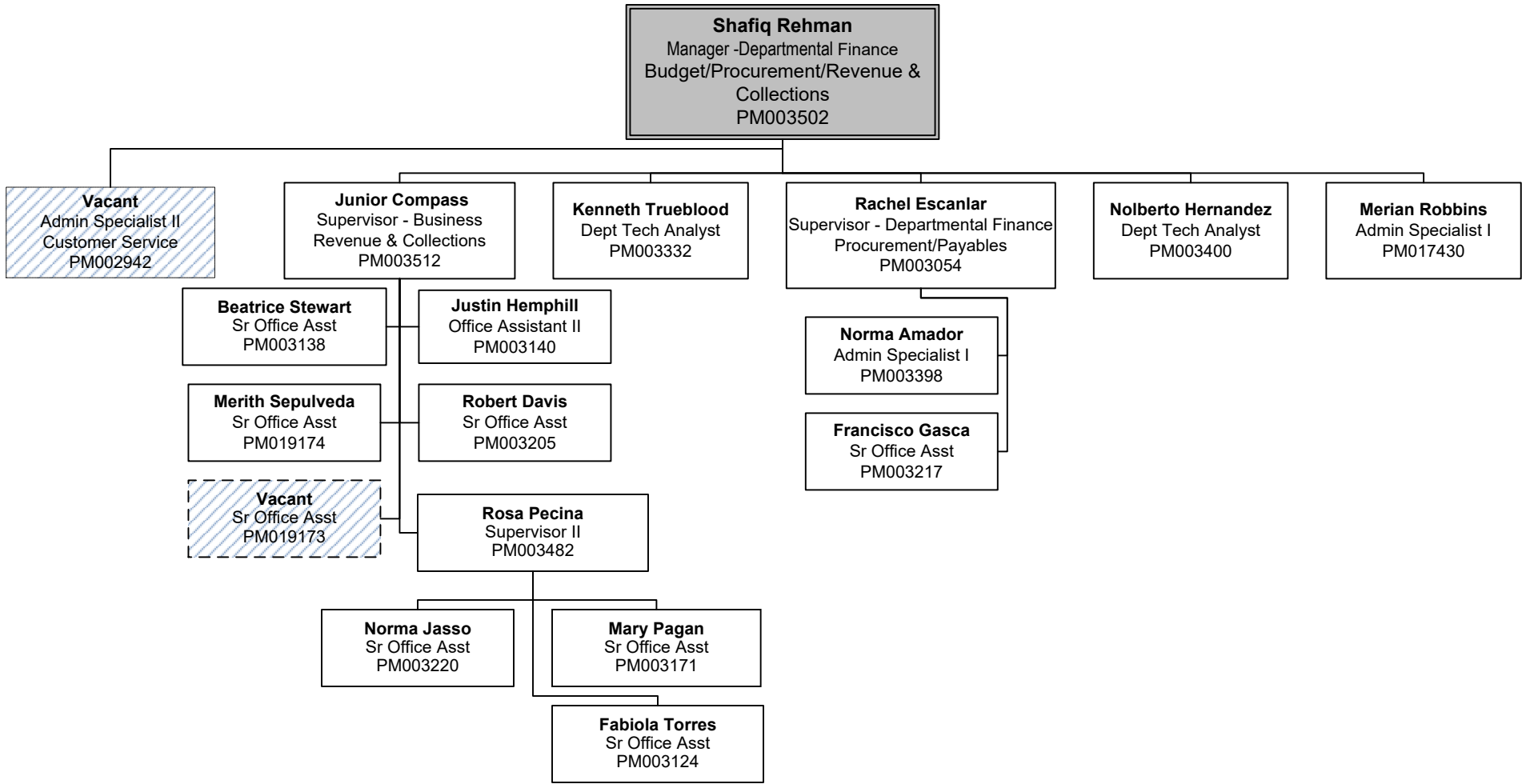

Department of Code Compliance
Environmental Health & Safety,
And Quality Management System (3452)

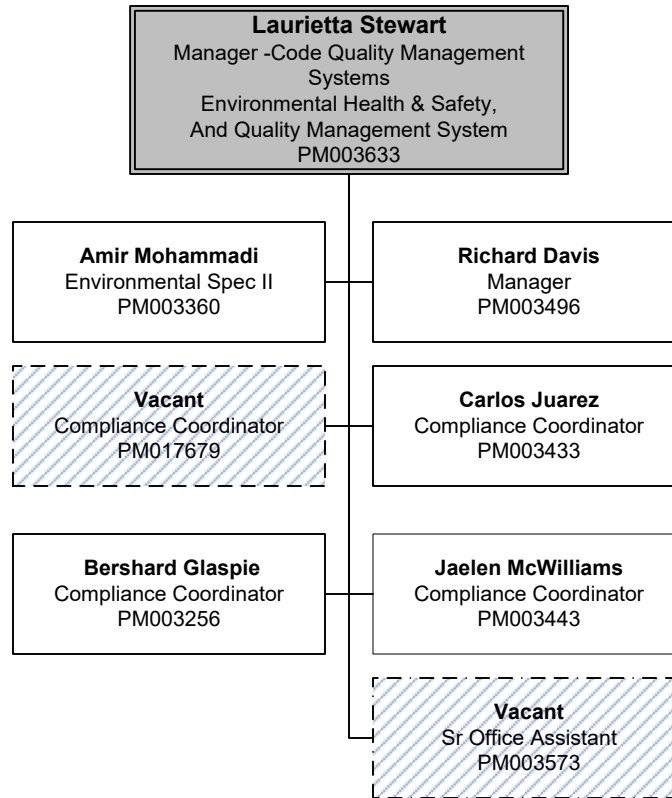

Department of Code Compliance
 Consumer Health
 Food Protection & Education (4221)
 7901 Goforth Road

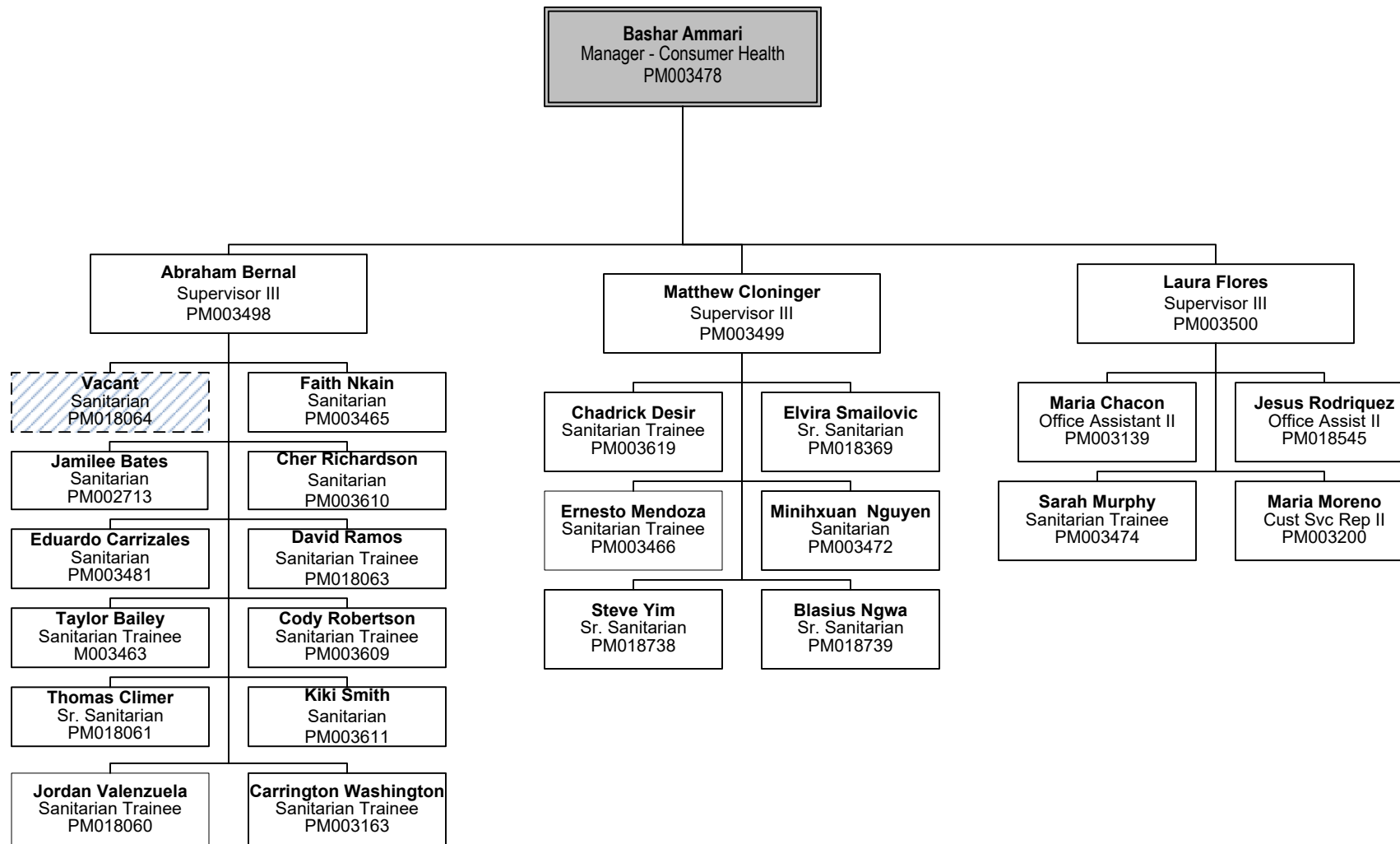

Department of Code Compliance
Consumer Health
Mosquito Abatement (4221)
7901 Goforth Road

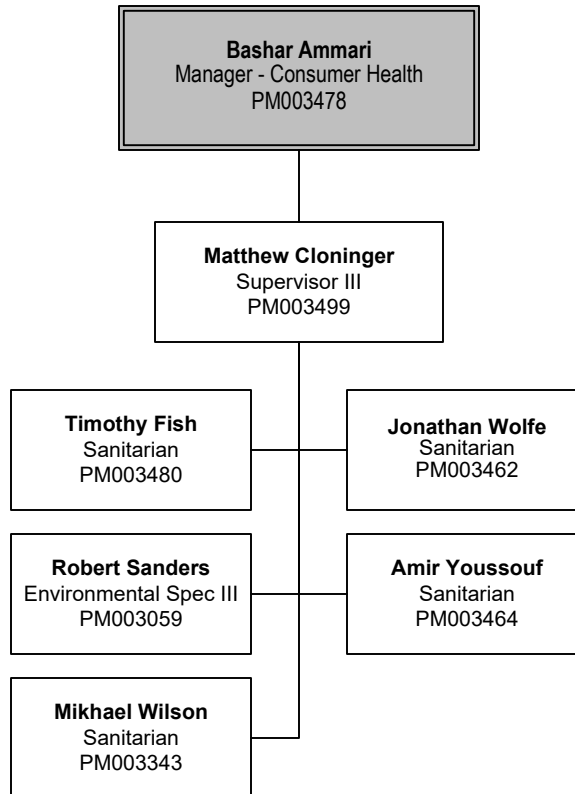

Department of Code Compliance
 NNA Administration (3470)
 Graffiti, and Secure Closures and Tire Abatement (3472)
 NNA Field Operations – Mow Clean and Heavy Clean Teams (3472)
 Administration (3452)
 Service First (3454)
 3112 Canton Street, 1st Floor

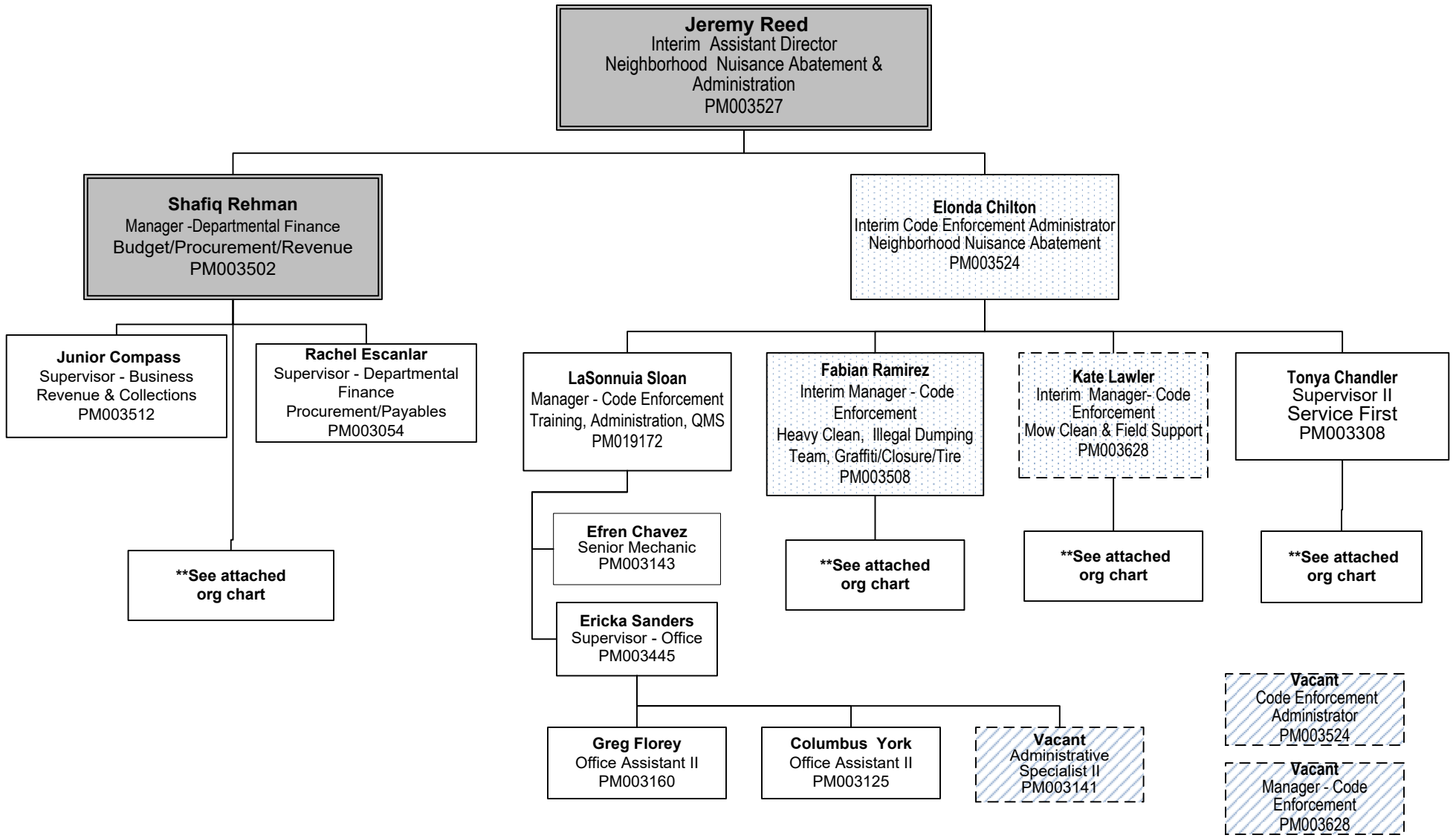

Neighborhood Nuisance Abatement
Mow Clean (3472)
2721 Municipal Street

Kate Lawler
Interim Manager- Code Enforcement
Mow Clean & Field Support
PM003628

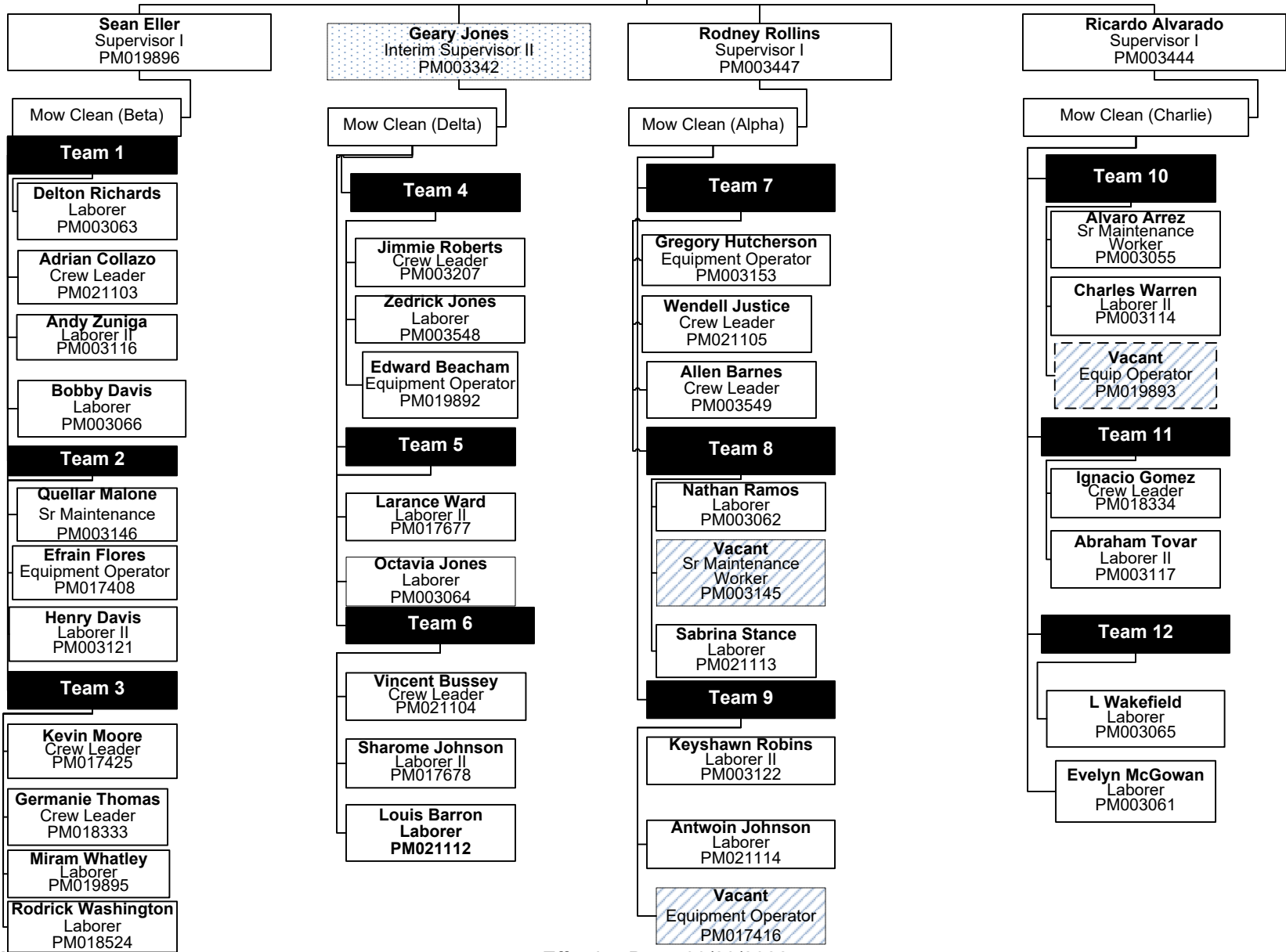

Neighborhood Nuisance Abatement
 Heavy Clean Teams, Illegal Dumping, and
 Graffiti/Closure/Tire, Tool Shed Pogram
 2721 Municipal Street

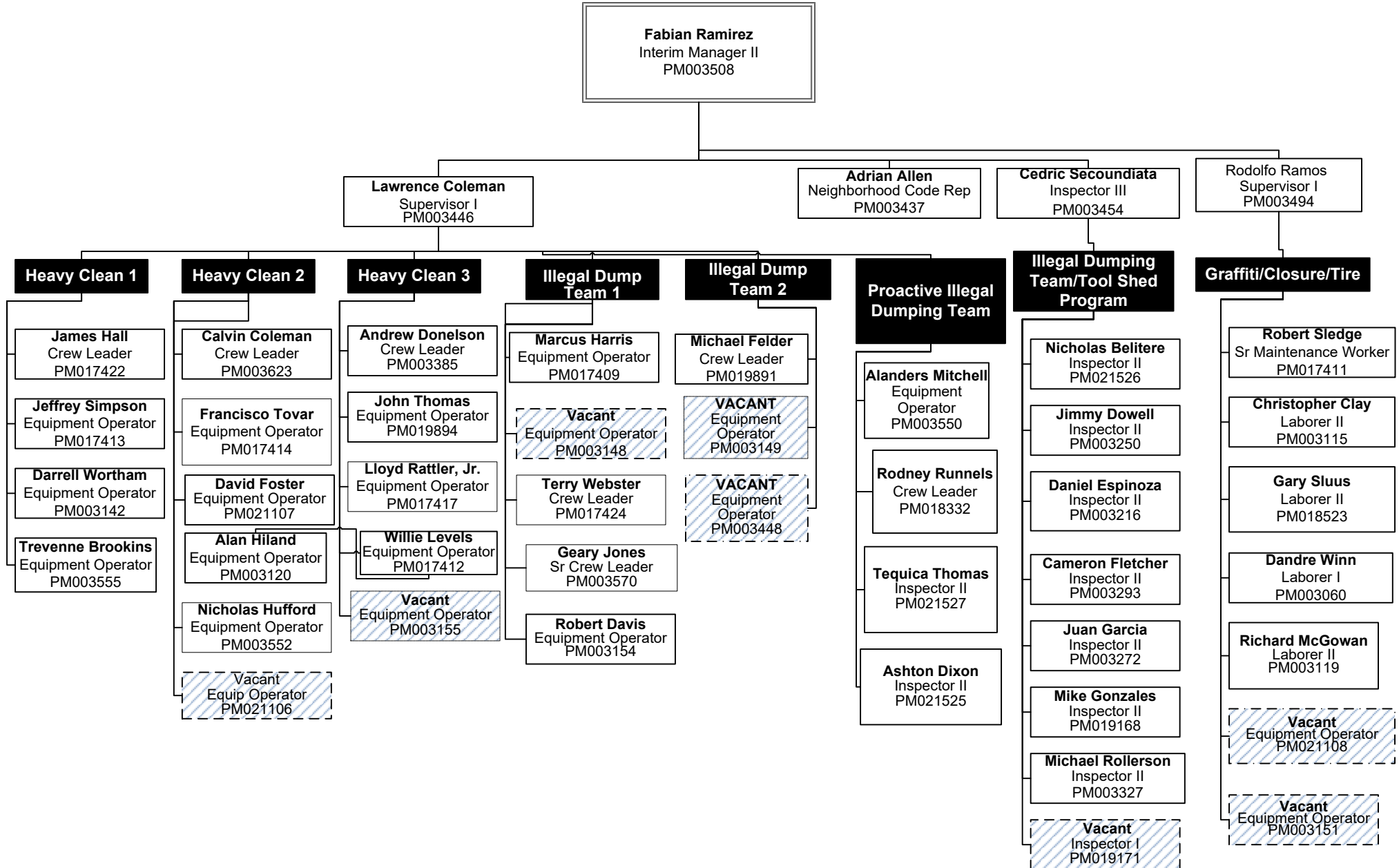

Department of Code Compliance
Neighborhood Code Districts
3112 Canton Street, 1st Floor

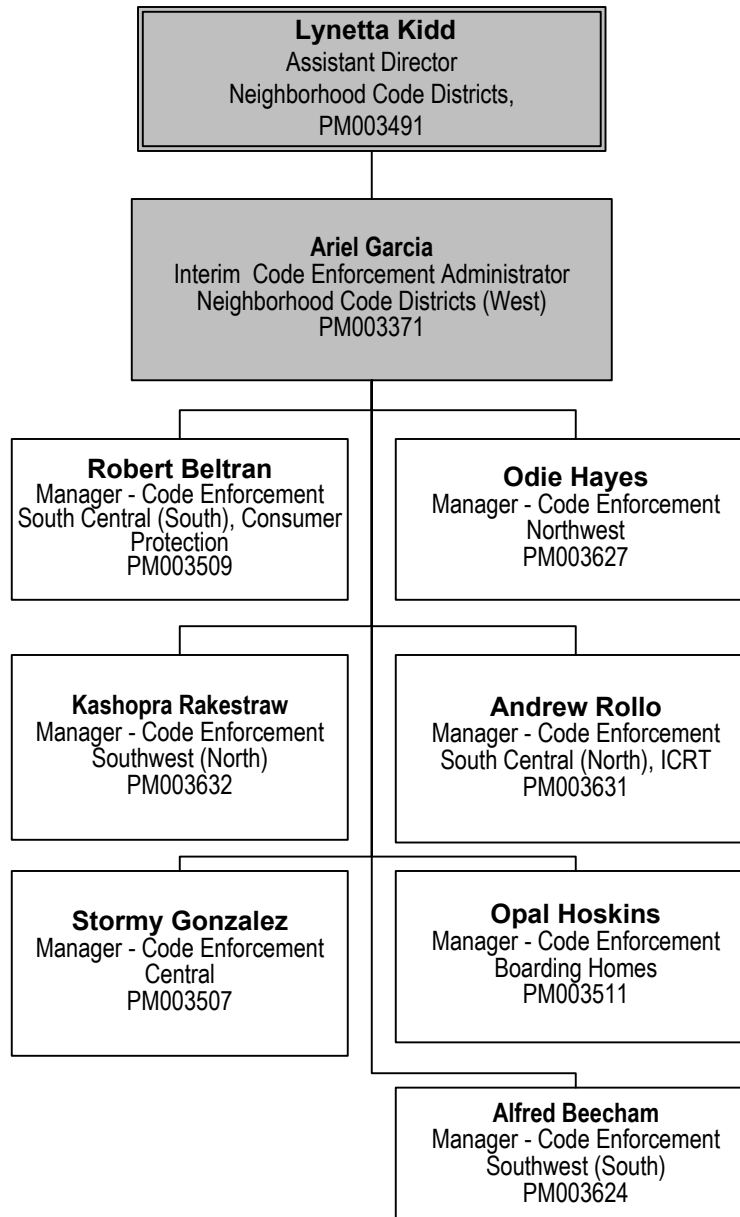

Vacant
Office Assistant II
PM003159

Neighborhood Code Compliance
 Southwest (North) District (3454)
 4230 W. Illinois Avenue

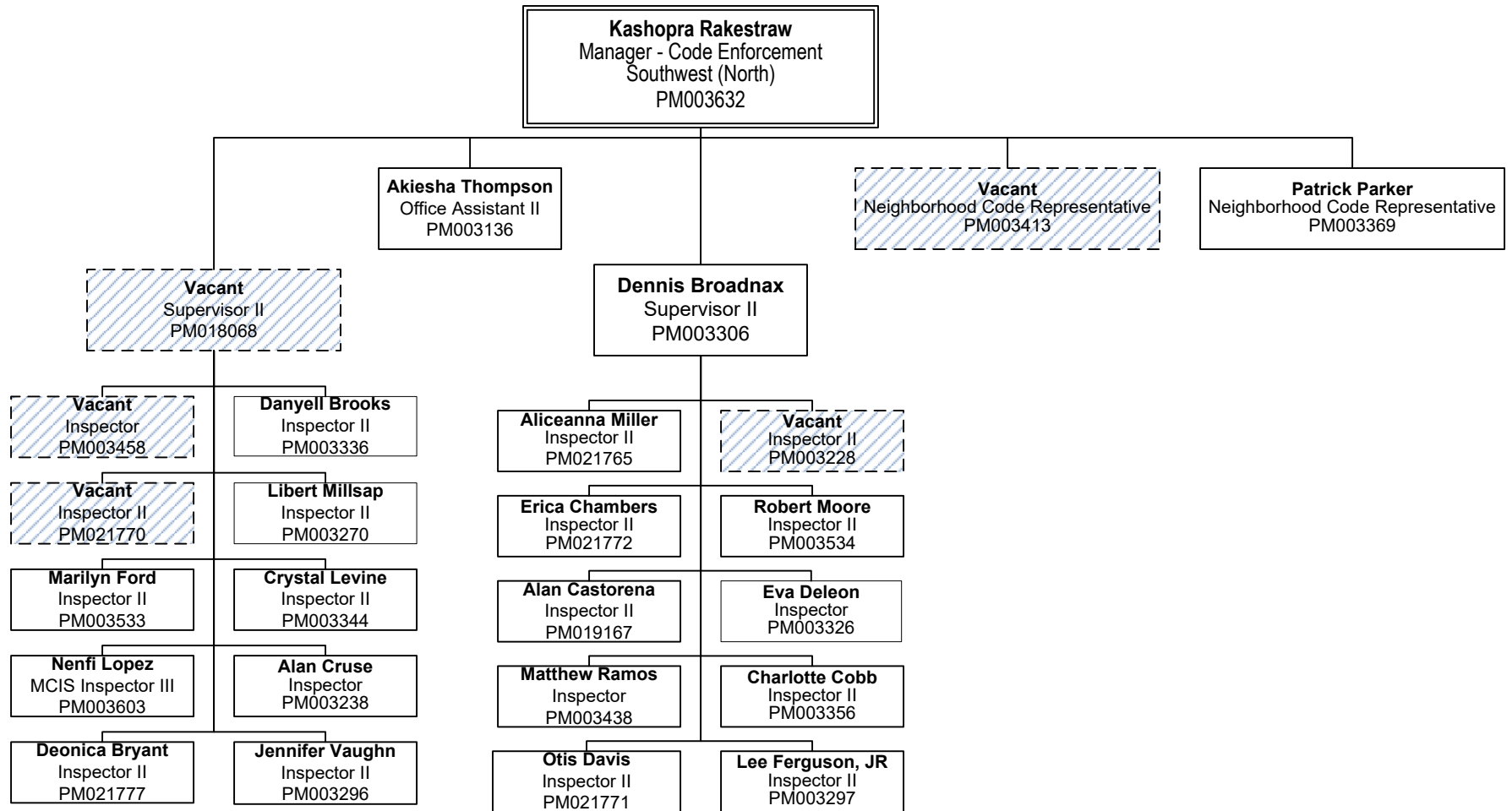

Neighborhood Code Compliance
Southwest (South) District (3454)
4230 W. Illinois Avenue

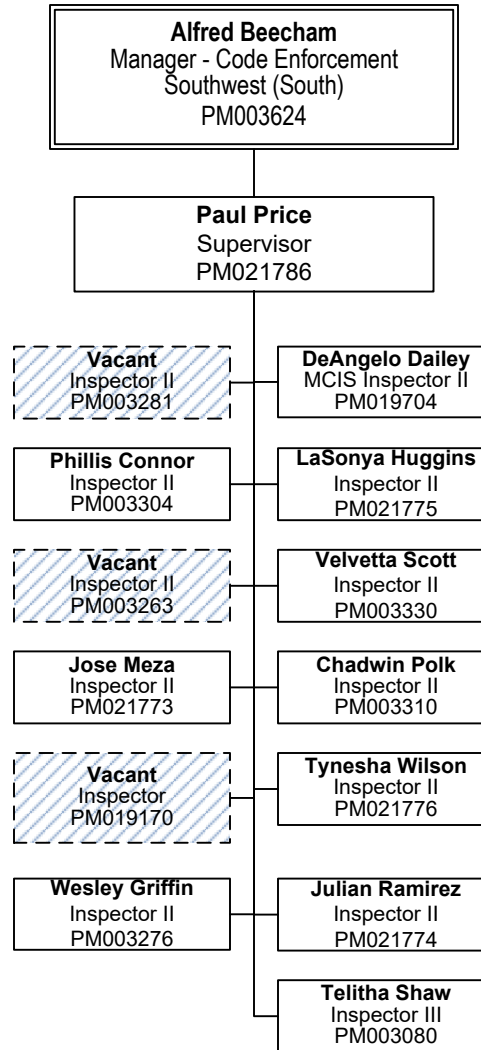

Department of Code Compliance
Boarding Home Facilities (3454)
4020 W. Illinois Ave

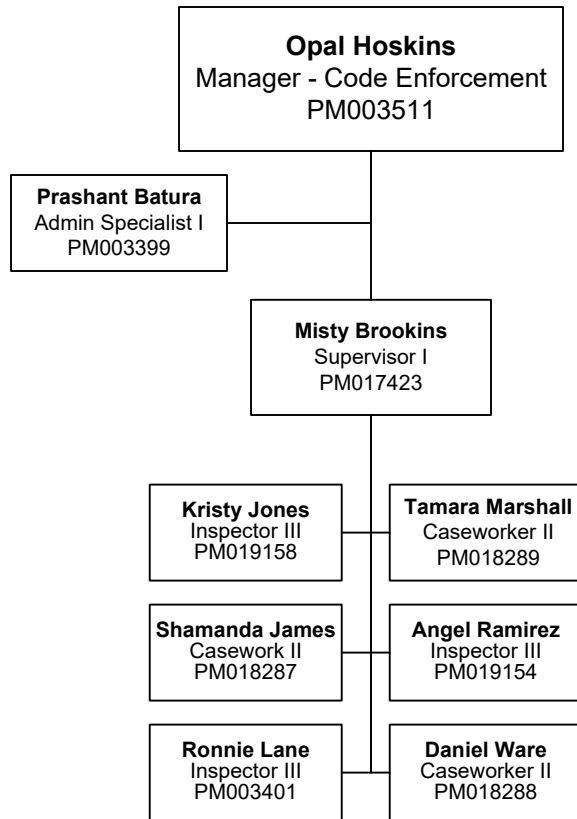

Department of Code Compliance
Service First
2721 Municipal Street

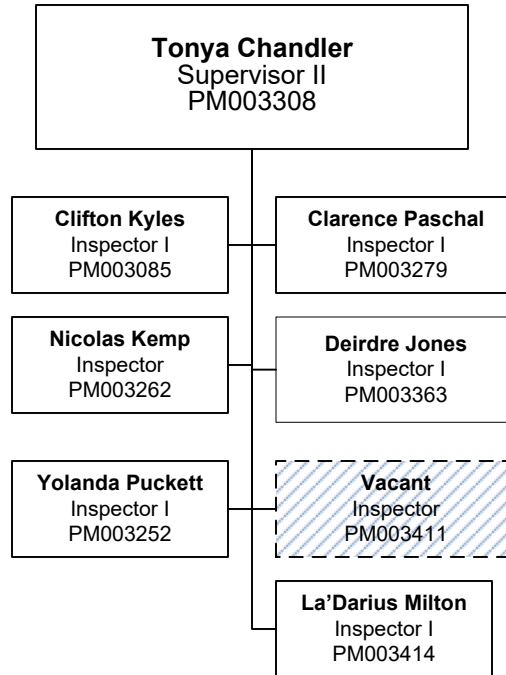

Neighborhood Code Compliance
Community Prosecution and
North Central District (3454)
7901 Goforth Road

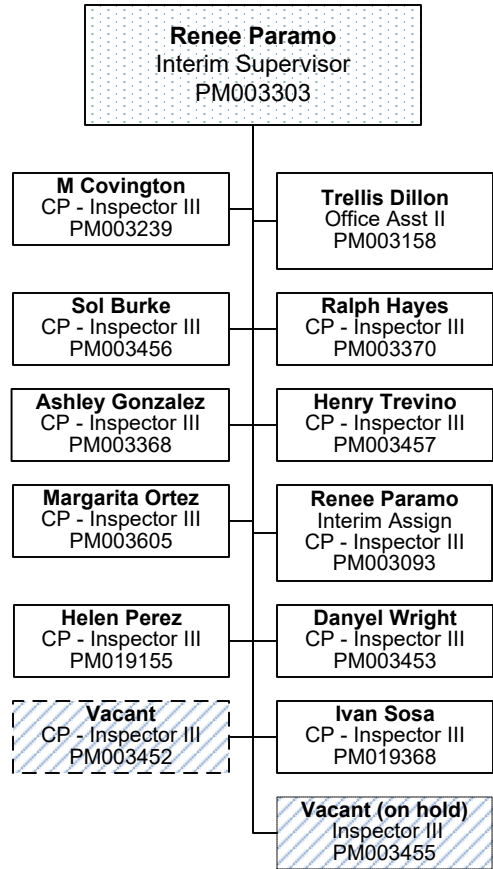

Neighborhood Code Compliance
 Northwest District (3454)
 9803 Harry Hines Blvd.

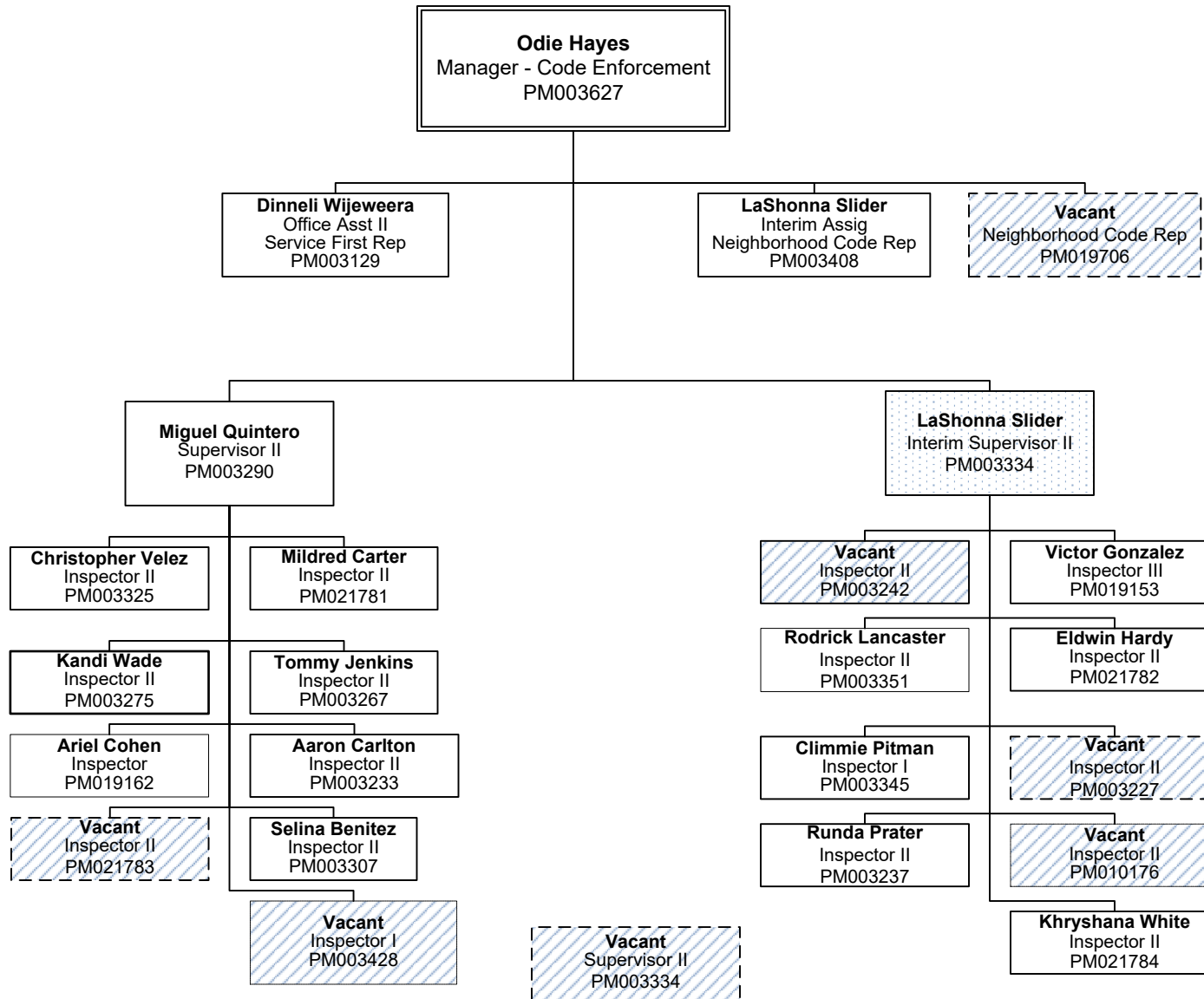

Neighborhood Code Compliance
 Central District (3454)
 320 E. Jefferson, #218

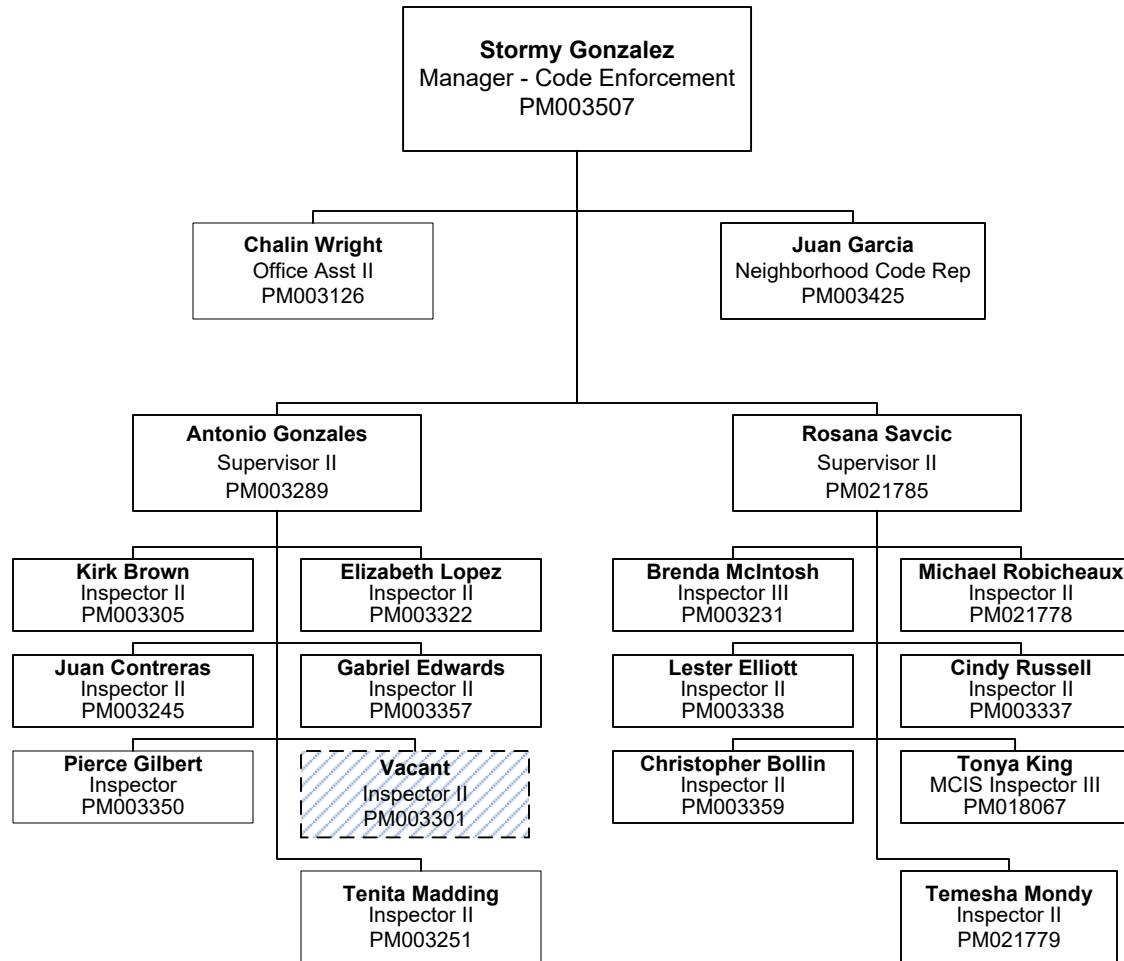

Neighborhood Code Compliance
 South Central- N (3454) and Intensive Case Resolution Team (3601), and
 Consumer Protection (3041), Demolition (3041), and STEP (3454)
 320 E. Jefferson, #208

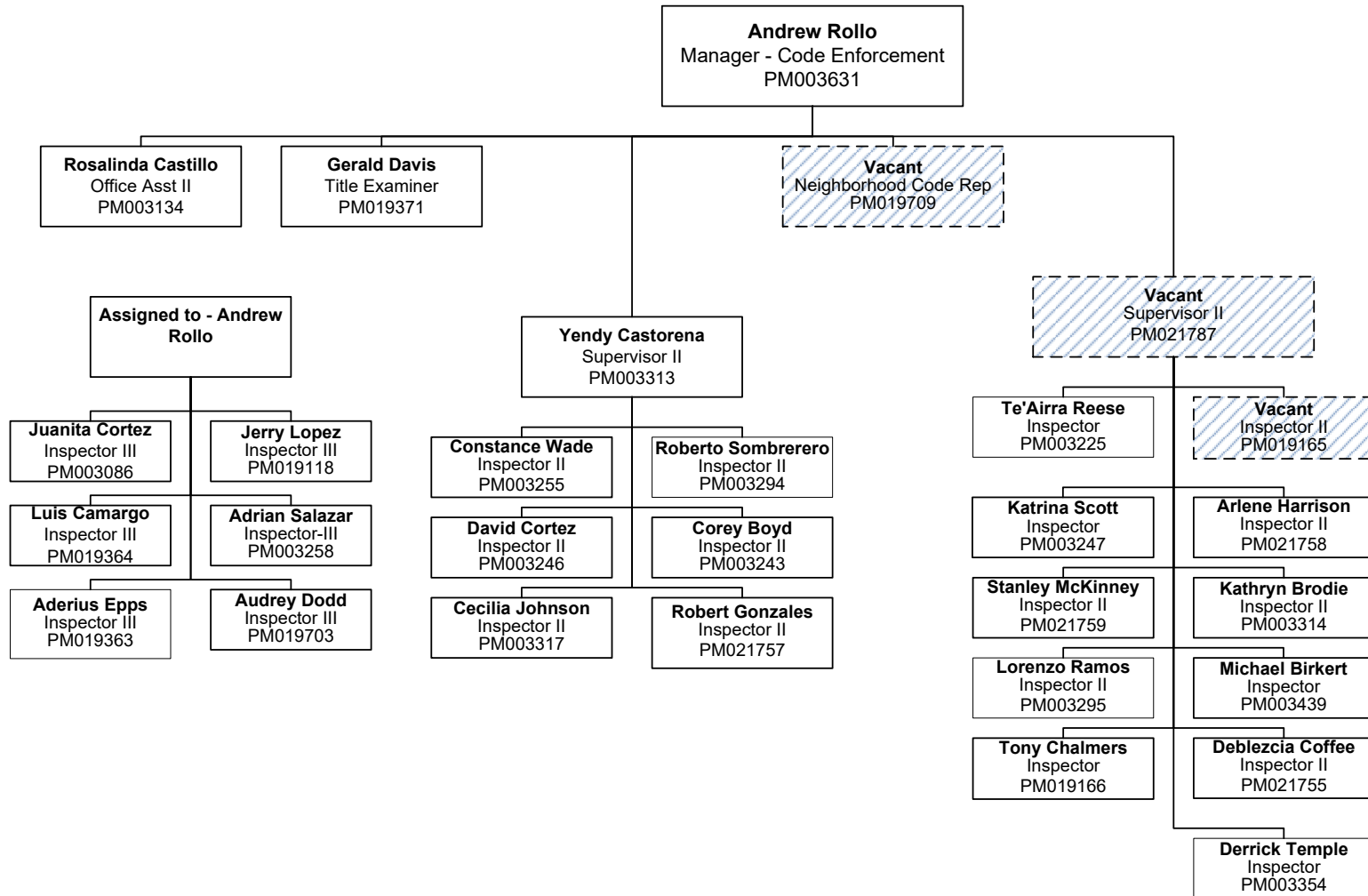

Department of Code Compliance
 South Central- S (3454) and Consumer Protection (3041),
 Demolition (3041), and STEP (3454)
 1500 Marilla Street

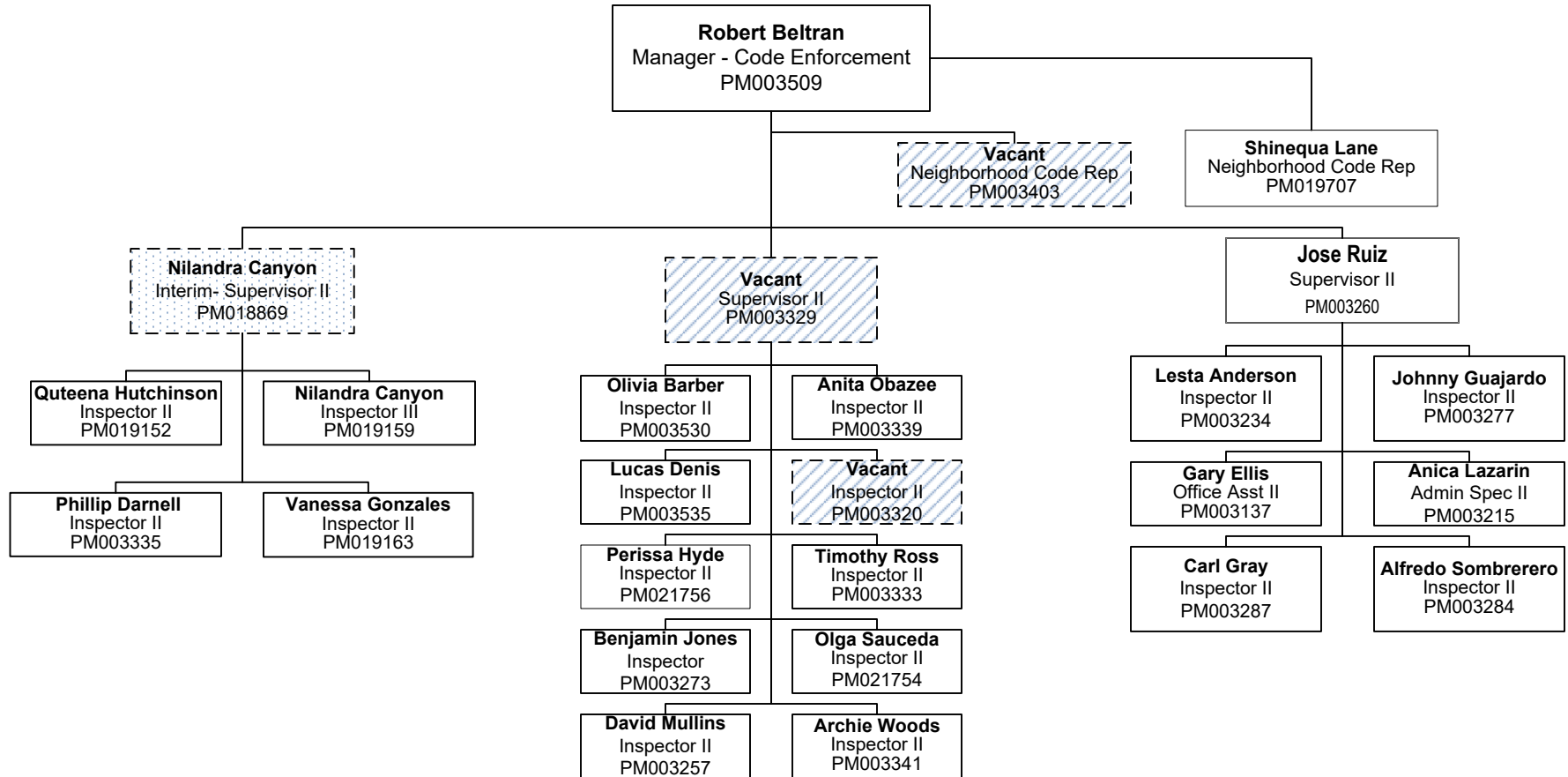

Neighborhood Code Compliance
 South East District (3454)
 2721 Municipal Street

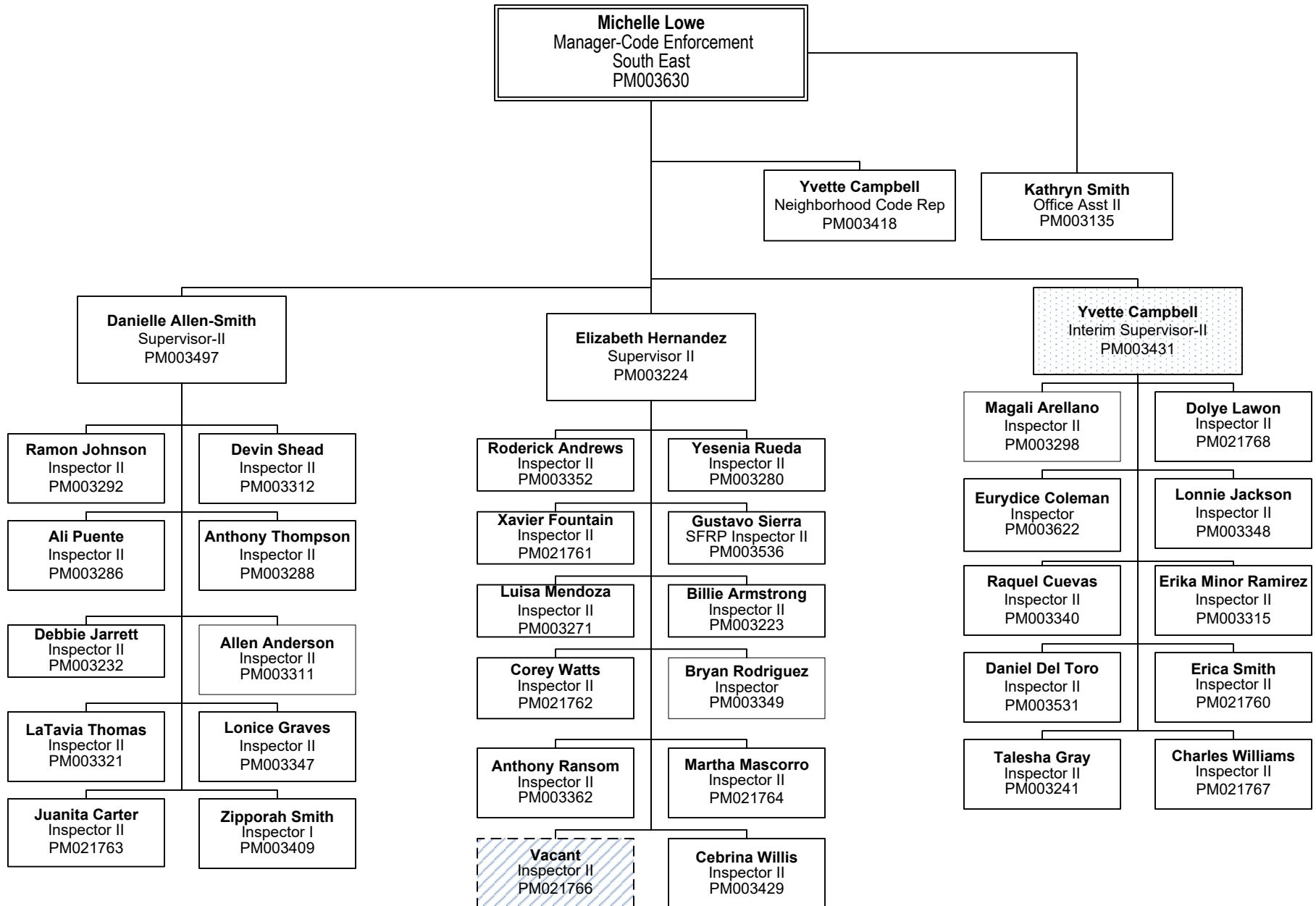

Neighborhood Code Compliance
Community Prosecution and
North Central District (3454)
7901 Goforth Road

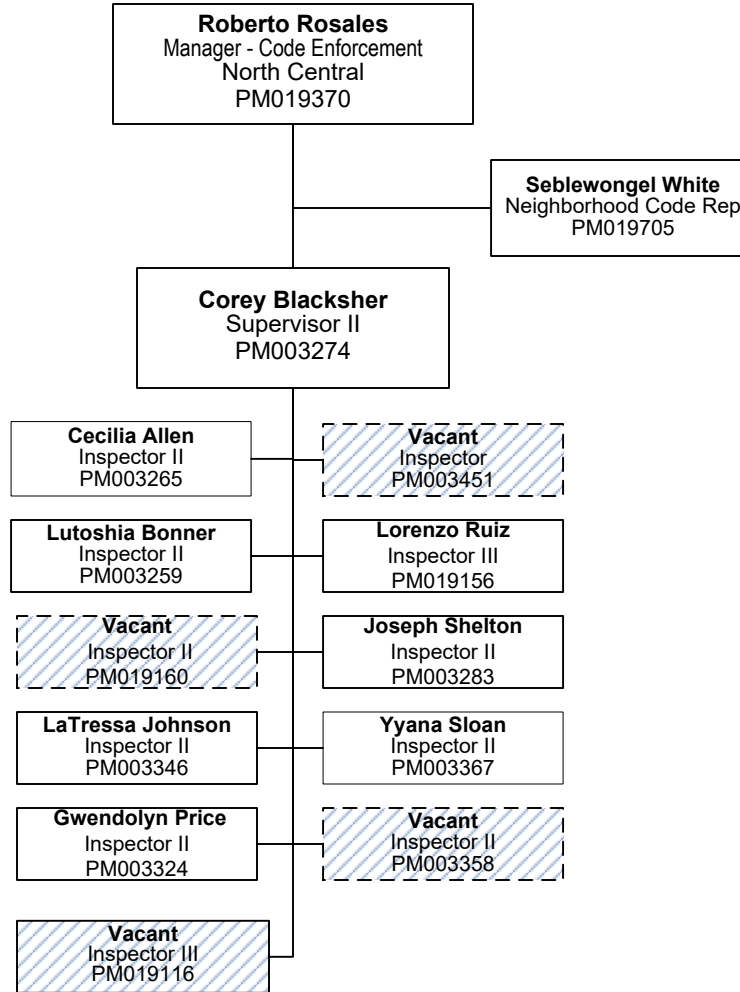

Neighborhood Code Compliance
 North East District (3454)
 7901 Goforth Road

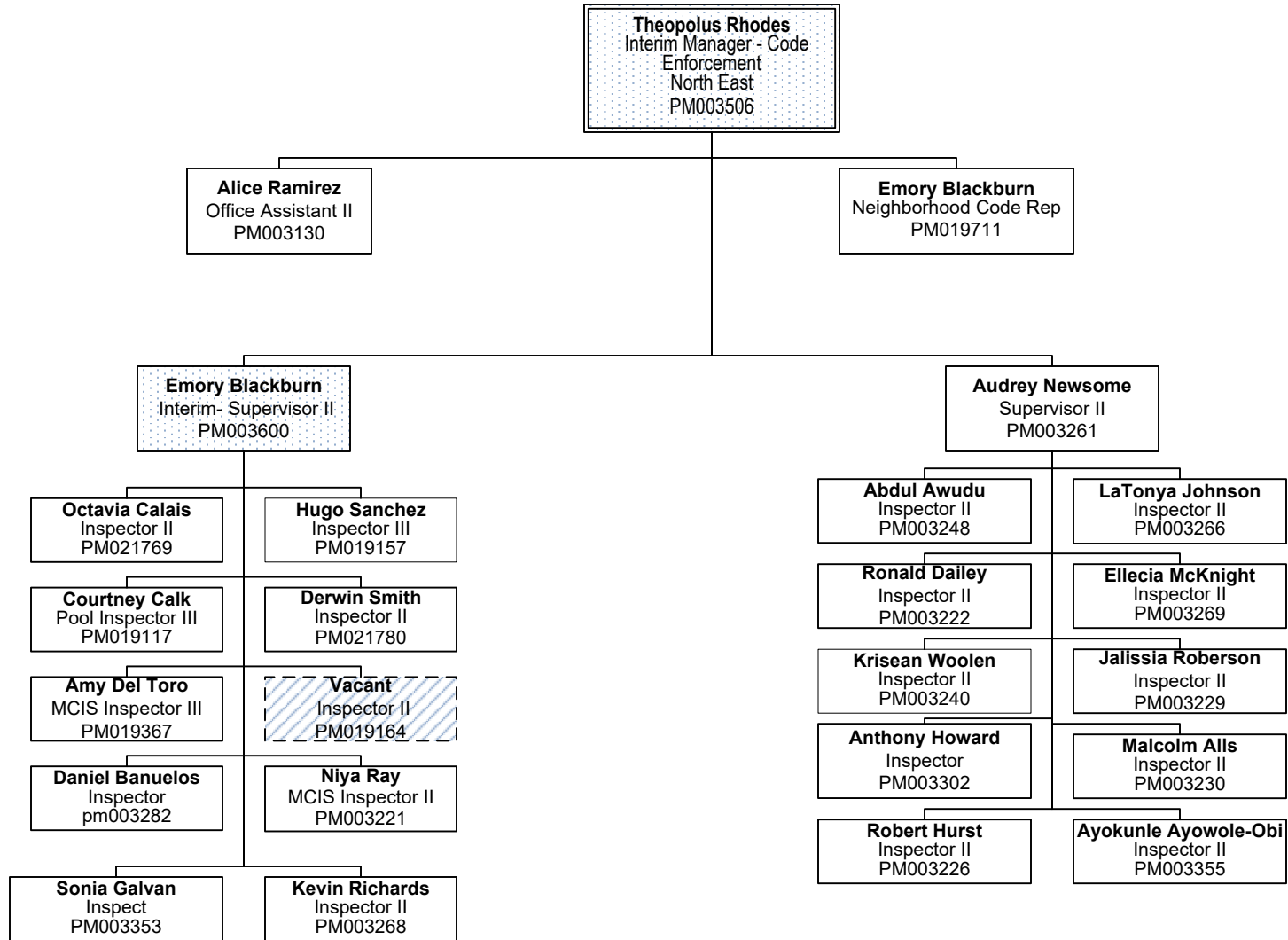

Positions Loaned To
Office of Integrated Public Safety Solutions(OIPSS)

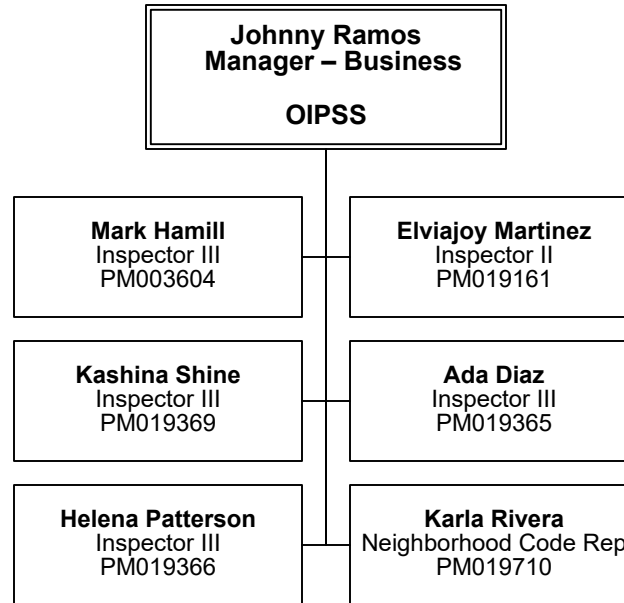

Department of
Code Compliance
Division & Unit Organization

