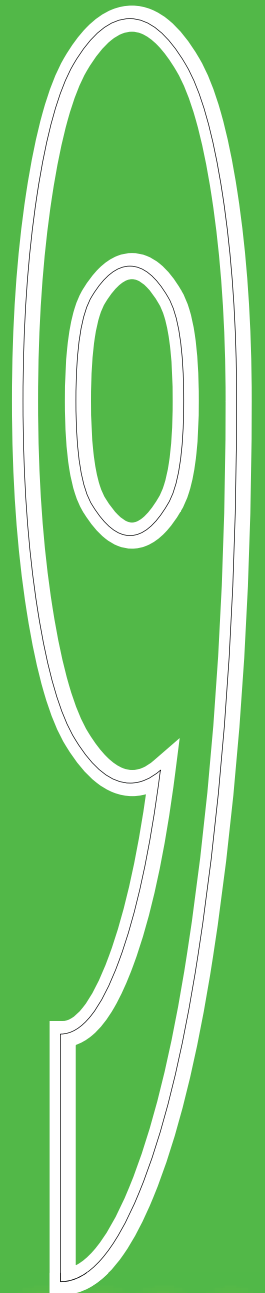


**Texas MUTCD**

# Part

**Traffic Control for  
Bicycle Facilities**



**2006**



**PART 9. TRAFFIC CONTROLS FOR BICYCLE FACILITIES****TABLE OF CONTENTS**

	<u>Page</u>
<b><u>SECTIONS</u></b>	
<b>CHAPTER 9A. GENERAL</b>	
Section 9A.01	Requirements for Bicyclist Traffic Control Devices.....9A-1
Section 9A.02	Scope .....9A-1
Section 9A.03	Definitions Relating to Bicycles .....9A-1
Section 9A.04	Maintenance .....9A-1
Section 9A.05	Relation to Other Documents.....9A-1
Section 9A.06	Placement Authority .....9A-2
Section 9A.07	Meaning of Standard, Guidance, Option, and Support.....9A-2
Section 9A.08	Colors .....9A-2
<b>CHAPTER 9B. SIGNS</b>	
Section 9B.01	Application and Placement of Signs .....9B-1
Section 9B.02	Design of Bicycle Signs .....9B-1
Section 9B.03	STOP and YIELD Signs (R1-1, R1-2).....9B-1
Section 9B.04	Bicycle Lane Signs (R3-17, R3-17a, R3-17b) .....9B-2
Section 9B.05	BEGIN RIGHT TURN LANE YIELD TO BIKES Sign (R4-4).....9B-2
Section 9B.06	Bicycle Wrong Way Sign and RIDE WITH TRAFFIC Plaque (R5-1b, R9-3c) .....9B-4
Section 9B.07	NO MOTOR VEHICLES Sign (R5-3).....9B-6
Section 9B.08	No Bicycles Sign (R5-6) .....9B-6
Section 9B.09	No Parking Bike Lane Signs (R7-9, R7-9a) .....9B-6
Section 9B.10	Bicycle Regulatory Signs (R9-5, R9-6, R10-3) .....9B-6
Section 9B.11	Shared-Use Path Restriction Sign (R9-7) .....9B-6
Section 9B.12	Bicycle Signal Actuation Sign (R10-22).....9B-6
Section 9B.13	Other Regulatory Signs .....9B-6
Section 9B.14	Turn or Curve Warning Signs (W1 Series) .....9B-6
Section 9B.15	Intersection Warning Signs (W2 Series) .....9B-7
Section 9B.16	Bicycle Surface Condition Warning Sign (W8-10).....9B-7
Section 9B.17	Bicycle Warning Sign (W11-1).....9B-7
Section 9B.18	Other Bicycle Warning Signs .....9B-7
Section 9B.19	Bicycle Route Guide Signs (D11-1) .....9B-9
Section 9B.20	Bicycle Route Signs (M1-8, M1-9).....9B-9
Section 9B.21	Destination Arrow and Supplemental Plaque Signs for Bicycle Route Signs.....9B-10
Section 9B.22	Bicycle Parking Area Sign (D4-3) .....9B-14
<b>CHAPTER 9C. MARKINGS</b>	
Section 9C.01	Functions of Markings .....9C-1
Section 9C.02	General Principles .....9C-1
Section 9C.03	Marking Patterns and Colors on Shared-Use Paths .....9C-1
Section 9C.04	Markings For Bicycle Lanes .....9C-4
Section 9C.05	Bicycle Detector Symbol .....9C-4
Section 9C.06	Pavement Markings for Obstructions.....9C-8
<b>CHAPTER 9D. SIGNALS</b>	
Section 9D.01	Application.....9D-1
Section 9D.02	Signal Operations for Bicycles .....9D-1

**FIGURES****CHAPTER 9B. SIGNS**

Figure 9B-1	Sign Placement on Shared-Use Paths .....	9B-2
Figure 9B-2	Regulatory Signs for Bicycle Facilities.....	9B-5
Figure 9B-3	Warning Signs for Bicycle Facilities.....	9B-8, 9
Figure 9B-4	Guide Signs for Bicycle Facilities.....	9B-10
Figure 9B-5	Example of Signing for the Beginning and End of a Designated Bicycle Route on a Shared-Use Path .....	9B-11
Figure 9B-6	Example of Signing for an On-Roadway Bicycle Route .....	9B-12
Figure 9B-7	Examples of Signing and Markings for Shared-Use Paths.....	9B-13

**CHAPTER 9C. MARKINGS**

Figure 9C-1	Example of Intersection Pavement Markings—Designated Bicycle Lane with Left-Turn Area, Heavy Turn Volumes, Parking, One-Way Traffic, or Divided Highway .....	9C-2
Figure 9C-2	Examples of Centerline Markings for Shared-Use Paths .....	9C-3
Figure 9C-3	Example of Bicycle Lane Treatment at a Right Turn Only Lane .....	9C-5
Figure 9C-4	Example of Bicycle Lane Treatment at Parking Lane into a Right Turn Only Lane .....	9C-6
Figure 9C-5	Example of Pavement Markings for Bicycle Lanes on a Two-Way Street.....	9C-7
Figure 9C-6	Example of Optional Word and Symbol Pavement Markings for Bicycle Lanes .....	9C-8
Figure 9C-7	Example of Bicycle Detector Pavement Marking .....	9C-9
Figure 9C-8	Example of Obstruction Pavement Marking .....	9C-9

**TABLES****CHAPTER 9B. SIGNS**

Table 9B-1	Minimum Sign Sizes for Bicycle Facilities .....	9B-3, 4
------------	-------------------------------------------------	---------

## CHAPTER 9A. GENERAL

### **Section 9A.01 Requirements for Bicyclist Traffic Control Devices**

Support:

General information and definitions concerning traffic control devices are found in Part 1.

### **Section 9A.02 Scope**

Support:

Part 9 covers signs, pavement markings, and highway traffic signals specifically related to bicycle operation on both roadways and shared-use paths.

Guidance:

Parts 1, 2, 3, and 4 should be reviewed for general provisions, signs, pavement markings, and signals.

**Standard:**

**None of the bikeway designations in this Manual shall be construed to preclude permitted bicycle travel on roadways or portions of roadways that do not have bikeway designations.**

### **Section 9A.03 Definitions Relating to Bicycles**

**Standard:**

**The following terms shall be defined as follows when used in Part 9:**

- 1. Bicycle Facilities—a general term denoting improvements and provisions that accommodate or encourage bicycling, including parking and storage facilities, and shared roadways not specifically defined for bicycle use.**
- 2. Bicycle Lane—a portion of a roadway that has been designated by signs and pavement markings for preferential or exclusive use by bicyclists.**
- 3. Bikeway—a generic term for any road, street, path, or way that in some manner is specifically designated for bicycle travel, regardless of whether such facilities are designated for the exclusive use of bicycles or are to be shared with other transportation modes.**
- 4. Designated Bicycle Route—a system of bikeways designated by the jurisdiction having authority with appropriate directional and informational route signs, with or without specific bicycle route numbers. Bicycle routes, which might be a combination of various types of bikeways, should establish a continuous routing.**
- 5. Shared-Use Path—a bikeway outside the traveled way and physically separated from motorized vehicular traffic by an open space or barrier and either within the highway right-of-way or within an independent alignment. Shared-use paths are also used by pedestrians (including skaters, users of manual and motorized wheelchairs, and joggers) and other authorized motorized and non-motorized users.**

### **Section 9A.04 Maintenance**

Guidance:

All signs, signals, and markings, including those on bicycle facilities, should be properly maintained to command respect from both the motorist and the bicyclist. When installing signs and markings on bicycle facilities, an agency should be designated to maintain these devices.

### **Section 9A.05 Relation to Other Documents**

Support:

“The Uniform Vehicle Code and Model Traffic Ordinance” published by the National Committee on Uniform Traffic Laws and Ordinances (see Section 1A.11) has provisions for bicycles and is the basis for the traffic control devices included herein.

Informational documents used during the development of the signing and marking recommendations in Part 9 include the following:

- A. “Guide for Development of Bicycle Facilities,” which is available from the American Association of State Highway and Transportation Officials (see Page i for the address);
- B. State and local government design guides; and
- C. “Selecting Roadway Design Treatments to Accommodate Bicycles,” FHWA Publication No. FHWA-RD-

92-073, which is available from the FHWA Research and Technology Report Center, 9701 Philadelphia Court, Unit Q, Lanham, MD 20106.

Other publications that relate to the application of traffic control devices in general are listed in Section 1A.11.

### **Section 9A.06 Placement Authority**

Support:

Section 1A.08 contains information regarding placement authority for traffic control devices.

### **Section 9A.07 Meaning of Standard, Guidance, Option, and Support**

Support:

The introduction to this Manual contains information regarding the meaning of the headings Standard, Guidance, Option, and Support, and the use of the words shall, should, and may.

### **Section 9A.08 Colors**

Support:

Section 1A.12 contains information regarding the color codes.

## CHAPTER 9B. SIGNS

### **Section 9B.01 Application and Placement of Signs**

#### **Standard:**

**Bicycle signs shall be standard in shape, legend, and color.**

**All signs shall be retroreflectorized for use on bikeways, including shared-use paths and bicycle lane facilities.**

**Where signs serve both bicyclists and other road users, vertical mounting height and lateral placement shall be as specified in Part 2.**

**On shared-use paths, lateral sign clearance shall be a minimum of 3 ft. and a maximum of 6 ft. from the near edge of the sign to the near edge of the path (see Figure 9B-1).**

**Mounting height for ground-mounted signs on shared-use paths shall be a minimum of 4 ft. and a maximum of 5 ft., measured from the bottom edge of the sign to the near edge of the path surface (see Figure 9B-1).**

**When overhead signs are used on shared-use paths, the clearance from the bottom edge of the sign to the path surface directly under the sign shall be a minimum of 8 ft.**

#### **Guidance:**

Signs for the exclusive use of bicyclists should be located so that other road users are not confused by them.

The clearance for overhead signs on shared-use paths should be adjusted when appropriate to accommodate typical maintenance vehicles.

### **Section 9B.02 Design of Bicycle Signs**

#### **Standard:**

**If the sign applies to motorists and bicyclists, then the size shall be as shown for conventional roads in Table 2B-1 (See Appendix, pages A-1 to A-29).**

**The minimum sign sizes for shared-use paths shall be those shown in Table 9B-1, and shall be used only for signs installed specifically for bicycle traffic applications. The minimum sign sizes for bicycle facilities shall not be used for signs that are placed in a location that would have any application to other vehicles.**

#### **Option:**

Larger size signs may be used on bicycle facilities when appropriate.

#### **Guidance:**

Except for size, the design of signs for bicycle facilities should be identical to that specified in this Manual for vehicular travel.

#### **Support:**

Uniformity in design includes shape, color, symbols, wording, lettering, and illumination or retroreflectorization.

### **Section 9B.03 STOP and YIELD Signs (R1-1, R1-2)**

#### **Standard:**

**STOP (R1-1) signs (see Figure 9B-2) shall be installed on shared-use paths at points where bicyclists are required to stop.**

**YIELD (R1-2) signs (see Figure 9B-2) shall be installed on shared-use paths at points where bicyclists have an adequate view of conflicting traffic as they approach the sign, and where bicyclists are required to yield the right-of-way to that conflicting traffic.**

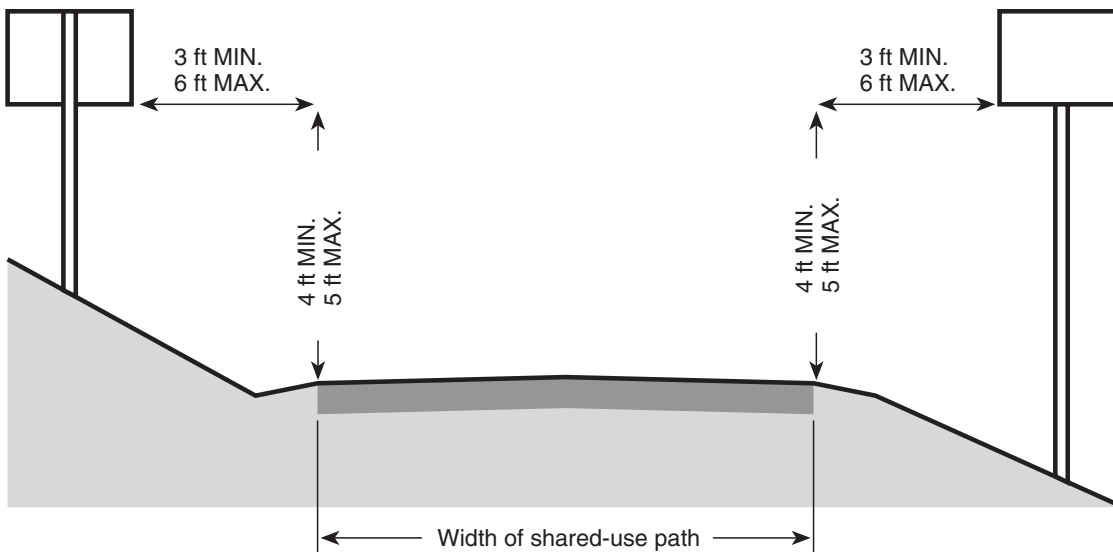
#### **Option:**

A 30 x 30 inch STOP sign or a 36 x 36 x 36 inch YIELD sign may be used on shared-use paths for added emphasis.

#### **Guidance:**

Where conditions require path users, but not roadway users, to stop or yield, the STOP sign or YIELD sign should be placed or shielded so that it is not readily visible to road users.

When placement of STOP or YIELD signs is considered, priority at a shared-use path/roadway intersection should be assigned with consideration of the following:

**Figure 9B-1. Sign Placement on Shared-Use Paths**

- A. Relative speeds of shared-use path and roadway users;
- B. Relative volumes of shared-use path and roadway traffic; and
- C. Relative importance of shared-use path and roadway.

Speed should not be the sole factor used to determine priority, as it is sometimes appropriate to give priority to a high-volume shared-use path crossing a low-volume street, or to a regional shared-use path crossing a minor collector street.

When priority is assigned, the least restrictive control that is appropriate should be placed on the lower priority approaches. STOP signs should not be used where YIELD signs would be acceptable.

#### **Section 9B.04 Bicycle Lane Signs (R3-17, R3-17a, R3-17b)**

##### **Standard:**

The Bike Lane (R3-17) sign (see Figure 9B-2) shall be used only in conjunction with marked bicycle lanes as described in Section 9C.04, and shall be placed at periodic intervals along the bicycle lanes.

##### **Guidance:**

The BIKE LANE (R3-17) sign spacing should be determined by engineering judgment based on prevailing speed of bicycle and other traffic, block length, distances from adjacent intersections, and other considerations.

The AHEAD (R3-17a) sign (see Figure 9B-2) should be mounted directly below a R3-17 sign in advance of the beginning of a marked bicycle lane.

The ENDS (R3-17b) sign (see Figure 9B-2) should be mounted directly below a R3-17 sign at the end of a marked bicycle lane.

#### **Section 9B.05 BEGIN RIGHT TURN LANE YIELD TO BIKES Sign (R4-4)**

##### **Option:**

Where motor vehicles entering an exclusive right-turn lane must weave across bicycle traffic in bicycle lanes, the BEGIN RIGHT TURN LANE YIELD TO BIKES (R4-4) sign (see Figure 9B-2) may be used to inform both the motorist and the bicyclist of this weaving maneuver.

##### **Guidance:**

The R4-4 sign should not be used when bicyclists need to move left because of a right-turn lane drop situation.



**Table 9B-1. Minimum Sign Sizes for Bicycle Facilities**  
(Sheet 1 of 2)

Sign	MUTCD Code	Minimum Sign Size - inches	
		Shared-Use Path	Roadway
Stop	R1-1	(18 x 18)	(30 x 30)
Yield	R1-2	(18 x 18 x 18)	(30 x 30 x 30)
Bike Lane	R3-17	-	(30 x 24)
Bicycle Lane Supplemental Plaques	R3-17a,b	-	(30 x 12)
Movement Restriction	R4-1,2,3,7	(12 x 18)	(18 x 24)
Begin Right Turn Lane Yield to Bikes	R4-4	-	(36 x 30)
Bicycle Wrong Way	R5-1b	(12 x 18)	(12 x 18)
No Motor Vehicles	R5-3	(24 x 24)	(24 x 24)
No Bicycles	R5-6	(24 x 24)	(24 x 24)
No Parking Bike Lane	R7-9,9a	-	(12 x 18)
Pedestrians Prohibited	R9-3a	(18 x 18)	(18 x 18)
Ride With Traffic Plaque	R9-3c	(12 x 12)	(12 x 12)
Bicycle Regulatory	R9-5,6	(12 x 18)	(12 x 18)
Shared-Use Path Restriction	R9-7	(12 x 18)	-
Push Button for Green Light	R10-3	(9 x 12)	(9 x 12)
To Request Green Wait on Symbol	R10-22	(12 x 18)	(12 x 18)
Railroad Crossbuck	R15-1	(24 x 4.5)	(48 x 9)
Turn and Curve Warning	W1-1,2,3,4,5	(18 x 18)	(24 x 24)
Arrow Warning	W1-6,7	(24 x 12)	(36 x 18)
Intersection Warning	W2-1,2,3,4,5	(18 x 18)	(24 x 24)
Stop,Yield,Signal Ahead	W3-1,2,3	(18 x 18)	(30 x 30)
Narrow Bridge	W5-2	(18 x 18)	(30 x 30)
Bikeway Narrows	W5-4a	(18 x 18)	(30 x 30)

**Table 9B-1. Minimum Sign Sizes for Bicycle Facilities  
(Sheet 2 of 2)**

Sign	MUTCD Code	Minimum Sign Size - inches	
		Shared-Use Path	Roadway
Hill	W7-5	(18 x 18)	(24 x 24)
Bump or Dip	W8-1,2	(18 x 18)	(24 x 24)
Bicycle Surface Condition	W8-10	(18 x 18)	(24 x 24)
Bicycle Surface Condition Plaque	W8-10p	(12 x 9)	(12 x 9)
Advance Grade Crossing	W10-1	(15 Dia.)	(15 Dia.)
Bicycle Warning	W11-1	(18 x 18)	(24 x 24)
Pedestrian Crossing	W11-2	(18 x 18)	(24 x 24)
Low Clearance	W12-2	(18 x 18)	(30 x 30)
Playground	W15-1	(18 x 18)	(24 x 24)
Share the Road Plaque	W16-1	-	(18 x 24)
Diagonal Arrow Plaque	W16-7p	-	(24 x 12)
Bicycle Guide	D1-1b	(24 x 6)	(24 x 6)
Street Name	D1-1c	(18 x 6)	(18 x 6)
Bicycle Parking	D4-3	(12 x 18)	(12 x 18)
Bike Route	D11-1	(24 x 18)	(24 x 18)
Bicycle Route Sign	M1-8	(12 x 18)	(12 x 18)
Interstate Bicycle Route Sign	M1-9	(18 x 24)	(18 x 24)
Bicycle Route Supplemental Plaques	M4-11,12,13	(12 x 4)	(12 x 4)
Route Sign Supplemental Plaques	M7-1,2,3,4,5,6,7	(12 x 9)	(12 x 9)

### **Section 9B.06 Bicycle Wrong Way Sign and RIDE WITH TRAFFIC Plaque (R5-1b, R9-3c)**

#### **Option:**

The Bicycle WRONG WAY (R5-1b) sign and RIDE WITH TRAFFIC (R9-3c) plaque (see Figure 9B-2) may be placed facing wrong-way bicycle traffic, such as on the left side of a roadway.

This sign and plaque may be mounted back-to-back with other signs to minimize visibility to other traffic.

#### **Guidance:**

The RIDE WITH TRAFFIC plaque should be used only in conjunction with the Bicycle WRONG WAY sign, and should be mounted directly below the Bicycle WRONG WAY sign.

Figure 9B-2. Regulatory Signs for Bicycle Facilities



R1-1



R1-2



R3-17



R3-17a



R3-17b



R15-1



R4-1



R4-2



R4-3



R4-4



R4-7



R5-1b



R5-3



R5-6



R7-9



R7-9a



R9-3c



R9-3a



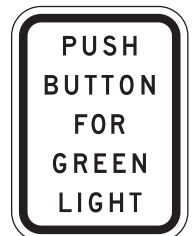
R9-5



R9-6



R9-7



R10-3



R10-22

**Section 9B.07 NO MOTOR VEHICLES Sign (R5-3)****Option:**

The NO MOTOR VEHICLES (R5-3) sign (see Figure 9B-2) may be installed at the entrance to a shared-use path.

**Section 9B.08 No Bicycles Sign (R5-6)****Guidance:**

Where bicyclists are prohibited, the No Bicycles (R5-6) sign (see Figure 9B-2) should be installed at the entrance to the facility.

**Option:**

Where pedestrians and motor-driven cycles are also prohibited, it may be more desirable to use the R5-10a word message sign that is described in Section 2B.36.

**Section 9B.09 No Parking Bike Lane Signs (R7-9, R7-9a)****Standard:**

**If the installation of signs is necessary to restrict parking, standing, or stopping in a bicycle lane, appropriate signs as described in Sections 2B.39 through 2B.41, or the No Parking Bike Lane (R7-9 or R7-9a) signs (see Figure 9B-2) shall be installed.**

**Section 9B.10 Bicycle Regulatory Signs (R9-5, R9-6, R10-3)****Option:**

The R9-5 sign (see Figure 9B-2) may be used where the crossing of a street by bicyclists is controlled by pedestrian signal indications.

Where it is not intended for bicyclists to be controlled by pedestrian signal indications, the R10-3 sign (see Figure 9B-2 and Section 2B.45) may be used.

The R9-6 sign (see Figure 9B-2) may be used where a bicyclist is required to cross or share a facility used by pedestrians and is required to yield to the pedestrians.

**Guidance:**

If used, the R9-5 or R10-3 signs should be installed near the edge of the sidewalk in the vicinity of where bicyclists will be crossing the street.

**Section 9B.11 Shared-Use Path Restriction Sign (R9-7)****Option:**

The Shared-Use Path Restriction (R9-7) sign (see Figure 9B-2) may be installed on facilities that are to be shared by pedestrians and bicyclists. The symbols may be switched as appropriate.

A designated pavement area may be provided for each mode of travel (see Section 9C.03).

**Section 9B.12 Bicycle Signal Actuation Sign (R10-22)****Option:**

The Bicycle Signal Actuation (R10-22) sign (see Figure 9B-2) may be installed at signalized intersections where markings are used to indicate the location where a bicyclist is to be positioned to actuate the signal (see Section 9C.05).

**Guidance:**

If the Bicycle Signal Actuation sign is installed, it should be placed at the roadside adjacent to the marking to emphasize the connection between the marking and the sign.

**Section 9B.13 Other Regulatory Signs****Option:**

Other regulatory signs described in Chapter 2B may be installed on bicycle facilities as appropriate.

**Section 9B.14 Turn or Curve Warning Signs (W1 Series)****Guidance:**

To warn bicyclists of unexpected changes in shared-use path direction, appropriate turn or curve (W1-1 through (W1-7) signs (see Figure 9B-3) should be used.

The W1-1 through W1-5 signs should be installed no less than 50 ft. in advance of the beginning of the change of alignment.

**Section 9B.15 Intersection Warning Signs (W2 Series)****Option:**

Intersection Warning (W2-1 through W2-5) signs (see Figure 9B-3) may be used on a roadway, street, or shared-use path in advance of an intersection to indicate the presence of an intersection and the possibility of turning or entering traffic.

**Guidance:**

When engineering judgment determines that the visibility of the intersection is limited on the shared-use path approach, Intersection Warning signs should be used.

Intersection Warning signs should not be used where the shared-use path approach to the intersection is controlled by a STOP sign, YIELD sign, or a traffic control signal.

**Section 9B.16 Bicycle Surface Condition Warning Sign (W8-10)****Option:**

The Bicycle Surface Condition Warning (W8-10) sign (see Figure 9B-3) may be installed where roadway or shared-use path conditions could cause a bicyclist to lose control of the bicycle. The educational plaque (W8-10p) may be placed below the W8-10 sign.

Signs warning of other conditions that might be of concern to bicyclists, including BUMP (W8-1), DIP (W8-2), PAVEMENT ENDS (W8-3), and any other word message that describes conditions that are of concern to bicyclists, may also be used.

A supplemental plaque may be used to clarify the specific type of surface condition.

**Section 9B.17 Bicycle Warning Sign (W11-1)****Support:**

The Bicycle Warning (W11-1) sign (see Figure 9B-3) alerts the road user to unexpected entries into the roadway by bicyclists, and other crossing activities that might cause conflicts. These conflicts might be relatively confined, or might occur randomly over a segment of roadway.

**Option:**

A supplemental plaque with the legend AHEAD or XXX FEET may be used with the Bicycle Warning sign.

**Guidance:**

If used in advance of a specific crossing point, the Bicycle Warning sign should be placed at a distance in advance of the crossing location that conforms with the guidance given in Table 2C-4.

**Standard:**

**Bicycle Warning signs, when used at the location of the crossing, shall be supplemented with a diagonal downward pointing arrow (W16-7p) plaque (see Figure 9B-3) to show the location of the crossing.**

**Option:**

A fluorescent yellow-green background color with a black legend and border may be used for Bicycle Warning signs and supplemental plaques.

**Guidance:**

When the fluorescent yellow-green background color is used, a systematic approach featuring one background color within a zone or area should be used. The mixing of standard yellow and fluorescent yellow-green backgrounds within a zone or area should be avoided.

**Section 9B.18 Other Bicycle Warning Signs****Option:**

Other bicycle warning signs (see Figure 9B-3) such as BIKEWAY NARROWS (W5-4a) and Hill (W7-5) may be installed on bicycle facilities to warn bicyclists of conditions not readily apparent. The educational plaque (W7-5a) may be placed below the W7-5 sign.

In situations where there is a need to warn motorists to watch for bicyclists traveling along the highway, the SHARE THE ROAD (W16-1) plaque (see Figure 9B-3) may be used in conjunction with the W11-1 sign.

**Guidance:**

If used, other advance bicycle warning signs should be installed no less than 50 ft. in advance of the beginning of the condition.

Where temporary traffic control zones are present on bikeways, appropriate signs from Part 6 should be used.

**Figure 9B-3. Warning Signs for Bicycle Facilities**  
(Sheet 1 of 2)



W1-1



W1-2



W1-3



W1-4



W1-5



W1-6



W1-7



W2-1



W2-2



W2-3



W2-4



W2-5



W3-1



W3-2



W3-3



W5-2



W5-4a



W7-5



W7-5a



W8-1



W8-2



W8-10



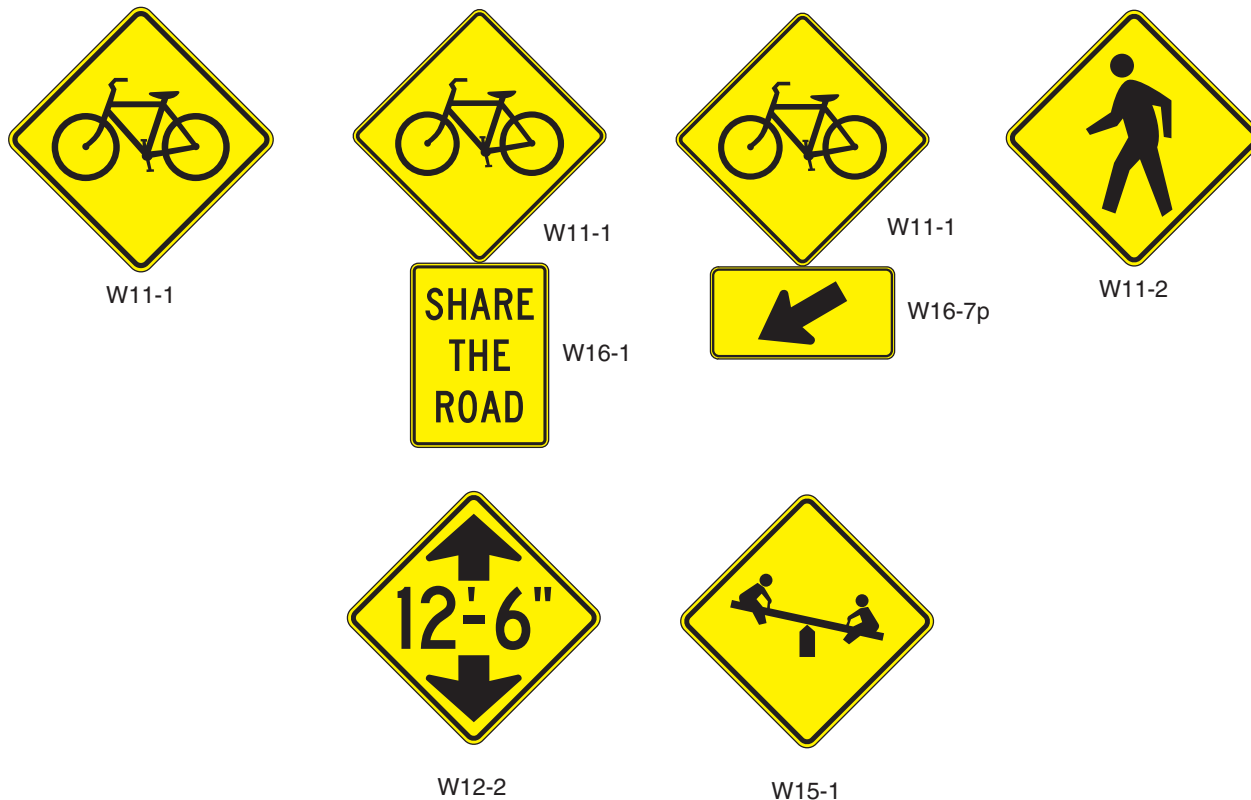
W8-10p



W10-1

**Figure 9B-3. Warning Signs for Bicycle Facilities**

(Sheet 2 of 2)

**Option:**

Other warning signs described in Chapter 2C may be installed on bicycle facilities as appropriate.

**Section 9B.19 Bicycle Route Guide Signs (D11-1)****Guidance:**

If used, Bicycle Route Guide (D11-1) signs (see Figure 9B-4) should be provided at decision points along designated bicycle routes, including signs to inform bicyclists of bicycle route direction changes and confirmation signs for route direction, distance, and destination.

If used, Bicycle Route Guide signs should be repeated at regular intervals so that bicyclists entering from side streets will have an opportunity to know that they are on a bicycle route. Similar guide signing should be used for shared roadways with intermediate signs placed for bicyclist guidance.

**Support:**

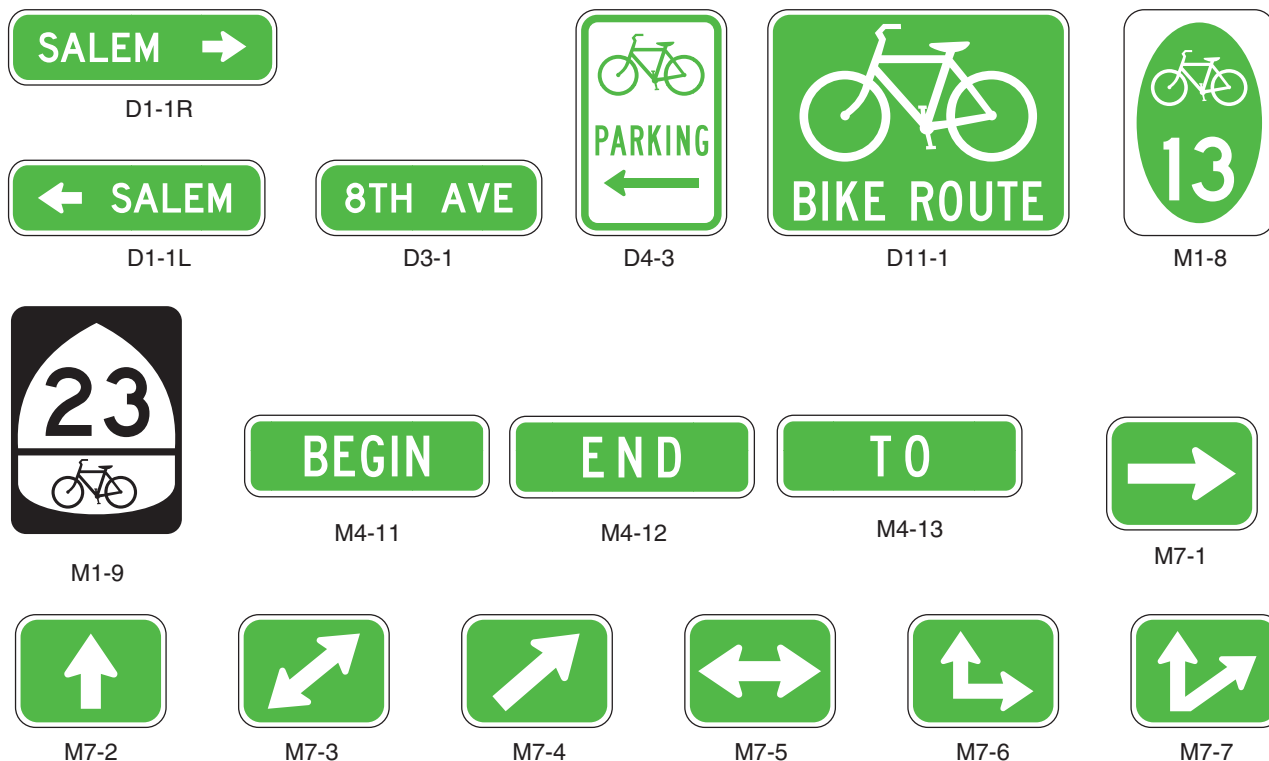
Figure 9B-5 shows an example of the signing for the beginning and end of a designated bicycle route on a shared-use path. Figure 9B-6 shows an example of signing for an on-roadway bicycle route. Figure 9B-7 shows examples of signing and markings for shared-use paths.

**Section 9B.20 Bicycle Route Signs (M1-8, M1-9)****Option:**

To establish a unique identification (route designation) for a State or local bicycle route, the Bicycle Route (M1-8) sign (see Figure 9B-4) may be used.

**Standard:**

**The Bicycle Route sign shall contain a route designation and shall have a green background with a retroreflectorized white legend and border.**

**Figure 9B-4. Guide Signs for Bicycle Facilities**

\* See "Standard Highway Sign Design" manual for M7 series regulatory.

**Option:**

Where a designated bicycle route extends for long distances through two or more States, a coordinated submittal by the affected States for an assignment of an Interstate Bicycle Route number designation may be sent to the American Association of State Highway and Transportation Officials (see Page i for the address).

**Standard:**

**The Interstate Bicycle Route (M1-9) sign (see Figure 9B-4) shall contain the assigned route number designation and have a black legend and border with a retroreflectorized white background.**

**Guidance:**

If used, the Bicycle Route or Interstate Bicycle Route signs should be placed at intervals frequent enough to keep bicyclists informed of changes in route direction and to remind motorists of the presence of bicyclists.

**Option:**

Bicycle Route or Interstate Bicycle Route signs may be installed on shared roadways or on shared-use paths to provide guidance for bicyclists.

The Bicycle Route Guide (D11-1) sign (see Figure 9B-4) may be installed where no unique designation of routes is desired.

**Section 9B.21 Destination Arrow and Supplemental Plaque Signs for Bicycle Route Signs**

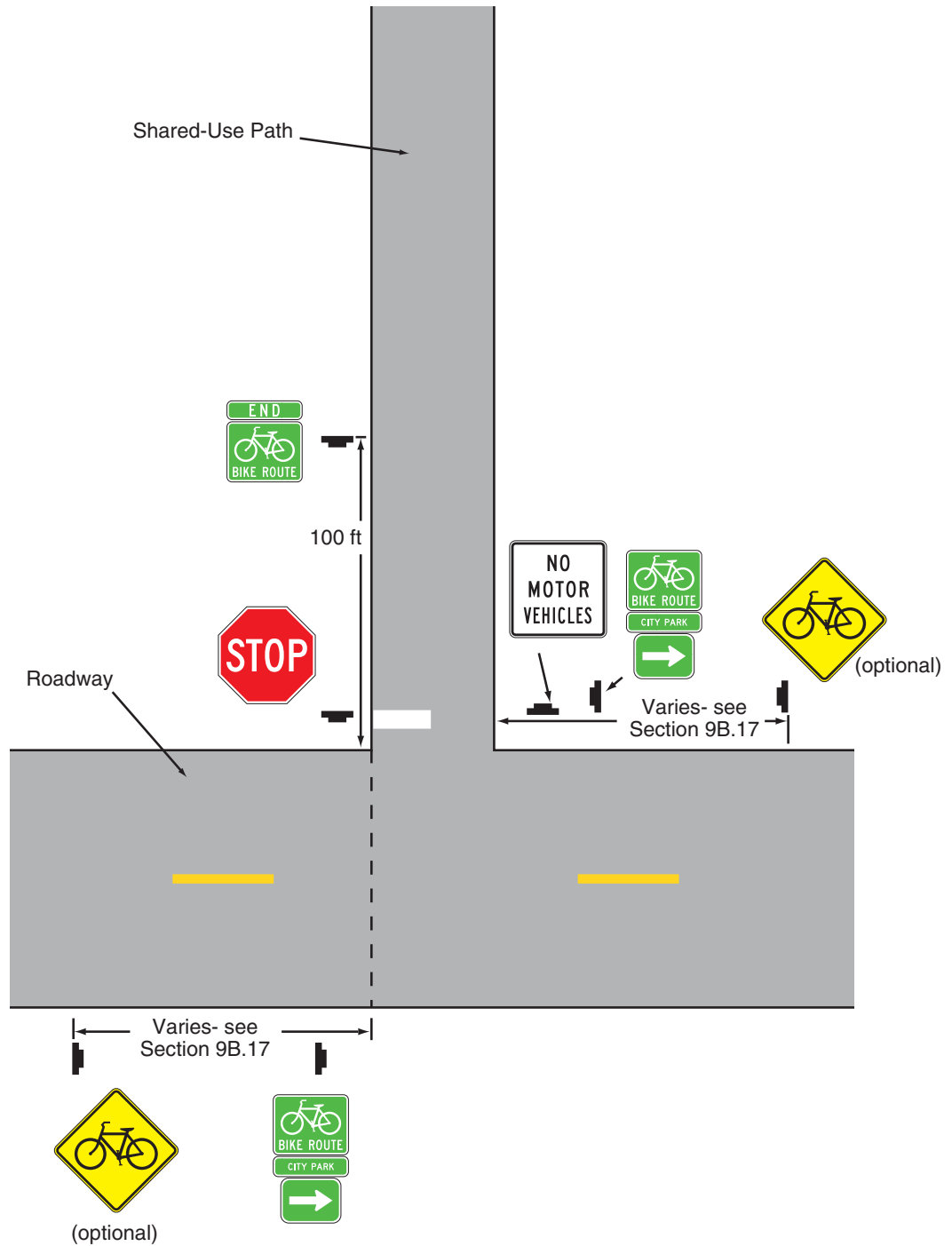
**Option:**

Destination (D1-1b and D1-1c) signs (see Figure 9B-4) may be mounted below Bicycle Route Guide signs, Bicycle Route signs, or Interstate Bicycle Route signs to furnish additional information, such as directional changes in the route, or intermittent distance and destination information.

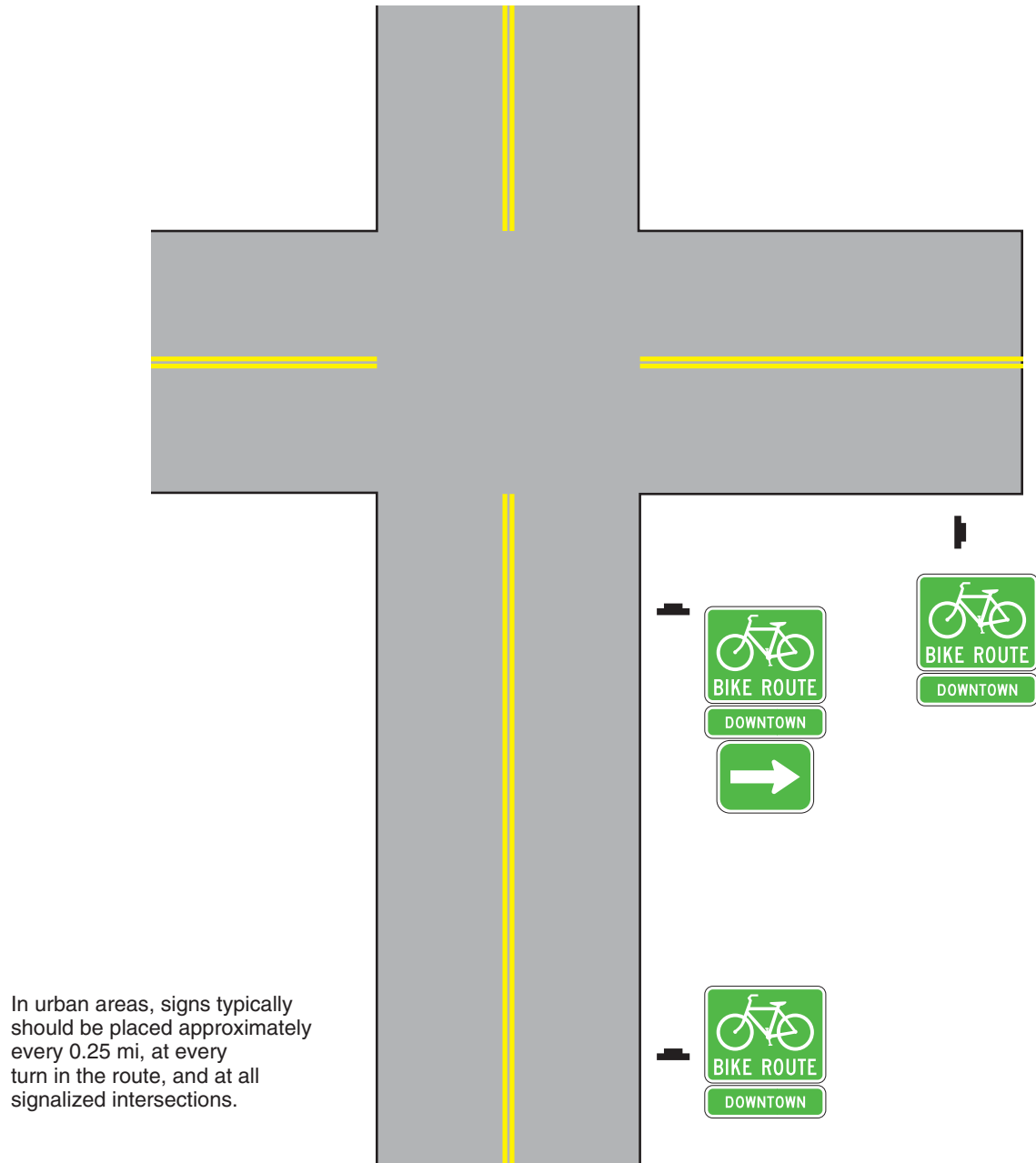
The M4-11 through M4-13 supplemental plaques (see Figure 9B-4) may be mounted above the appropriate Bicycle Route Guide signs, Bicycle Route signs, or Interstate Bicycle Route signs.



**Figure 9B-5. Example of Signing for the Beginning and End of a Designated Bicycle Route on a Shared-Use Path**

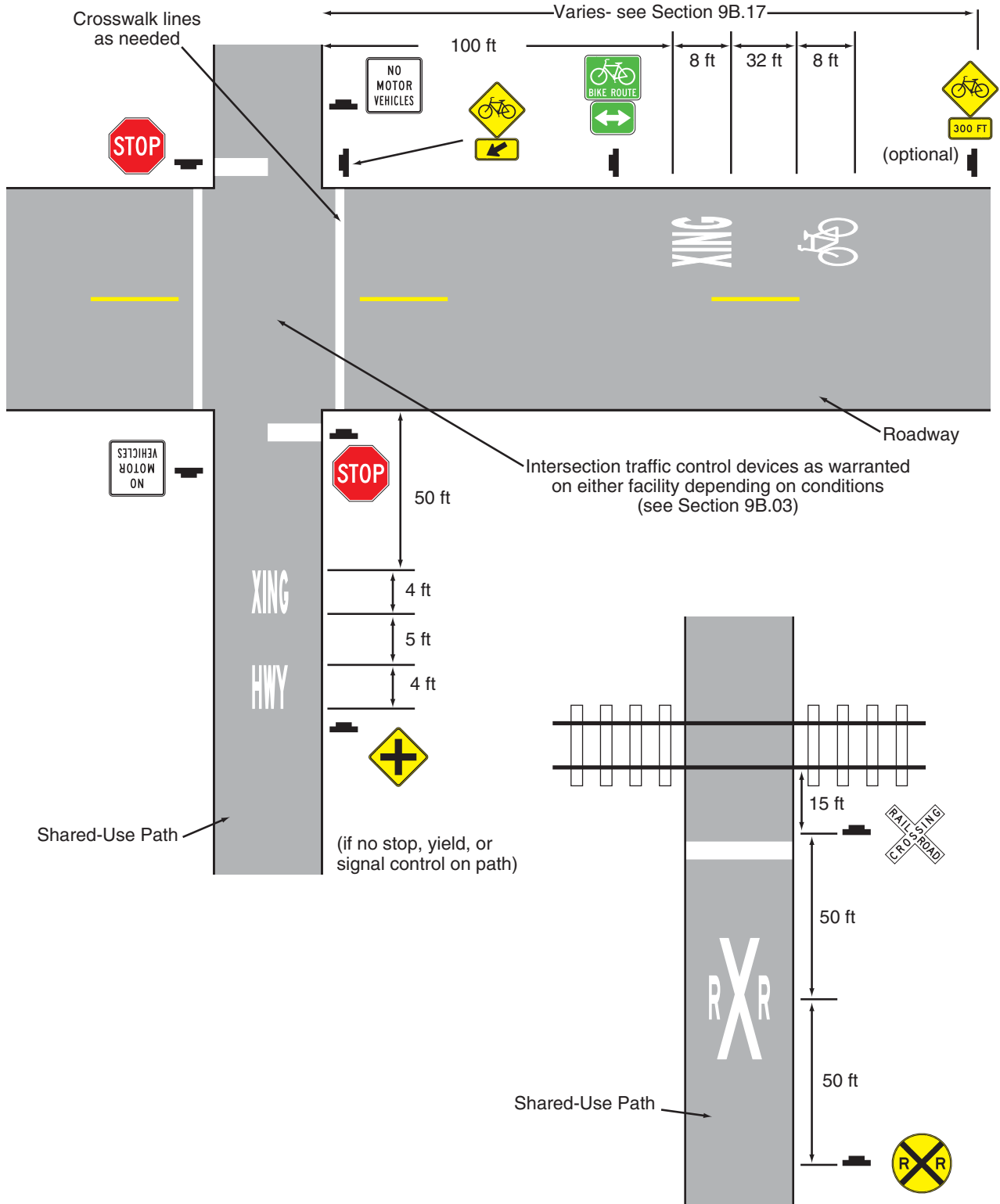


**Figure 9B-6. Example of Signing for an On-Roadway Bicycle Route**



In urban areas, signs typically should be placed approximately every 0.25 mi, at every turn in the route, and at all signalized intersections.

**Figure 9B-7. Examples of Signing and Markings for Shared-Use Paths**



**Guidance:**

If used, the appropriate arrow (M7-1 through M7-7) sign (see Figure 9B-4) should be placed below the Bicycle Route Guide sign, Bicycle Route sign, or Interstate Bicycle Route sign.

**Standard:**

**The arrow signs and supplemental plaques used with the D11-1 or M1-8 signs shall have a white legend and border on a green background.**

**The arrow signs and supplemental plaques used with the M1-9 sign shall have a white legend and border on a black background.**

**Section 9B.22 Bicycle Parking Area Sign (D4-3)****Option:**

The Bicycle Parking Area (D4-3) sign (see Figure 9B-4) may be installed where it is desirable to show the direction to a designated bicycle parking area. The arrow may be reversed as appropriate.

**Standard:**

**The legend and border of the Bicycle Parking Area sign shall be green on a retroreflectorized white background.**

## CHAPTER 9C. MARKINGS

### **Section 9C.01 Functions of Markings**

#### Support:

Markings indicate the separation of the lanes for road users, assist the bicyclist by indicating assigned travel paths, indicate correct position for traffic control signal actuation, and provide advance information for turning and crossing maneuvers.

### **Section 9C.02 General Principles**

#### Guidance:

Bikeway design guides should be used when designing markings for bicycle facilities (see Section 9A.05).

#### Standard:

**Markings used on bikeways shall be retroreflectorized.**

#### Guidance:

Pavement marking symbols and/or word messages should be used in bikeways where appropriate.

Consideration should be given to selecting pavement marking materials that will minimize loss of traction for bicycles under wet conditions.

#### Standard:

**The colors, width of lines, patterns of lines, and symbols used for marking bicycle facilities shall be as defined in Sections 3A.04, 3A.05, and 3B.22.**

#### Support:

Figures 9B-7 and 9C-1 through 9C-8 show examples of the application of lines, word messages, and symbols on designated bikeways.

#### Option:

A dotted line may be used to define a specific path for a bicyclist crossing an intersection (see Figure 9C-1) as described in Sections 3A.05 and 3B.08.

### **Section 9C.03 Marking Patterns and Colors on Shared-Use Paths**

#### Option:

Where shared-use paths are of sufficient width to designate two minimum width lanes, a solid yellow line may be used to separate the two directions of travel where passing is not permitted, and a broken yellow line may be used where passing is permitted (see Figure 9C-2).

#### Guidance:

Broken lines used on shared-use paths should have the usual 1-to-3 segment-to-gap ratio. A nominal 3 ft. segment with a 9 ft. gap should be used.

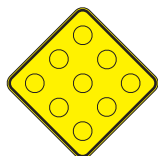
If conditions make it desirable to separate two directions of travel on shared-use paths at particular locations, a solid yellow line should be used to indicate no passing and no traveling to the left of the line.

Markings as shown in Figure 9C-2 should be used at the location of obstructions in the center of the path, including vertical elements intended to physically prevent unauthorized motor vehicles from entering the path.

#### Option:

A solid white line may be used on shared-use paths to separate different types of users. The R9-7 sign (see Figure 9B-2) may be used to supplement the solid white line.

Smaller size letters and symbols may be used on shared-use paths. Where arrows are needed on shared-use paths, half-size layouts of the arrows may be used (see Section 3B.19).



Type 1

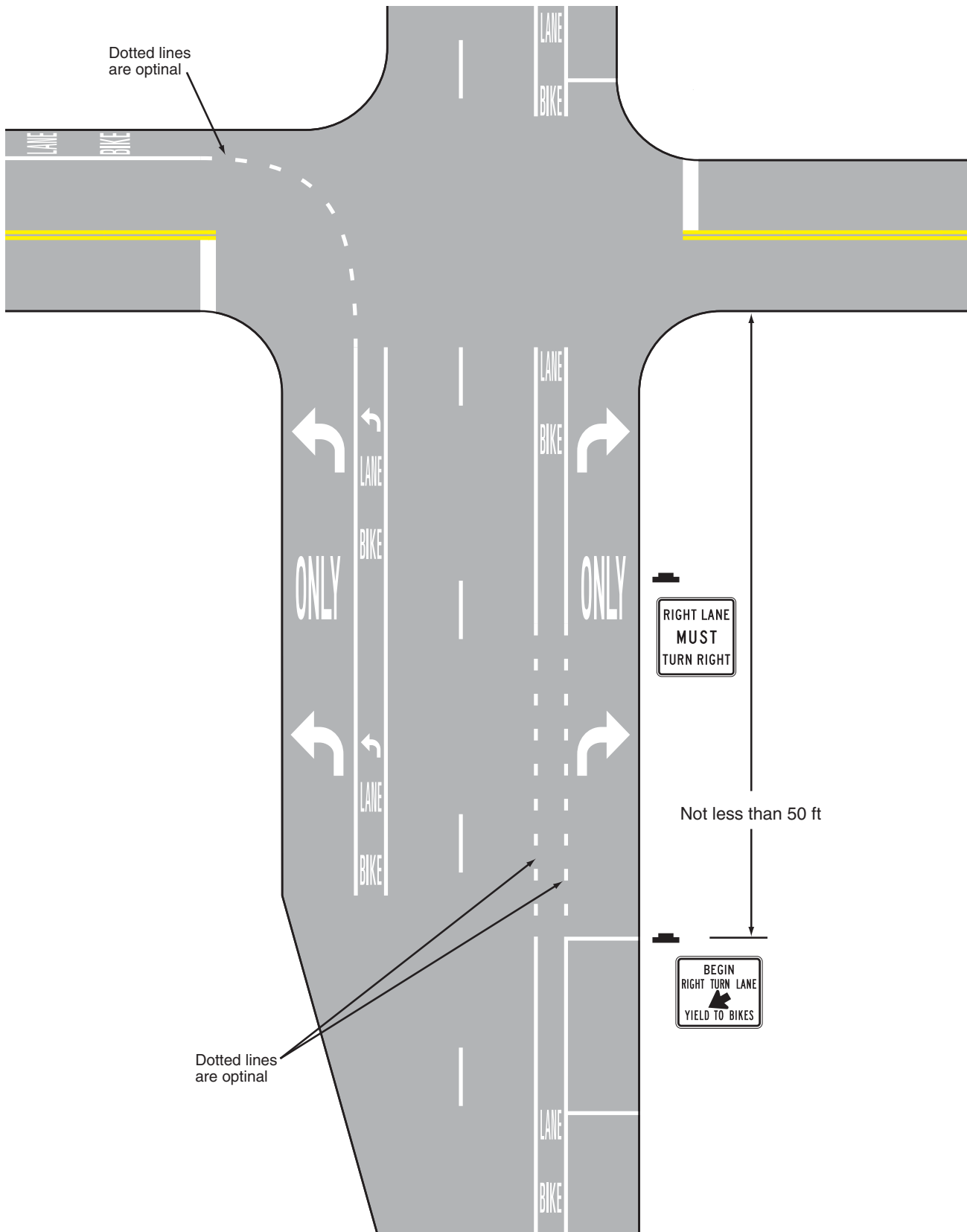


Type 2

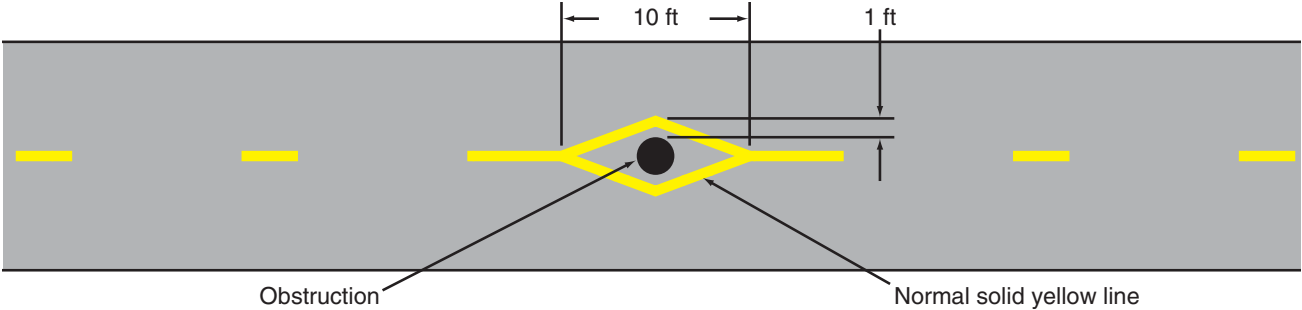
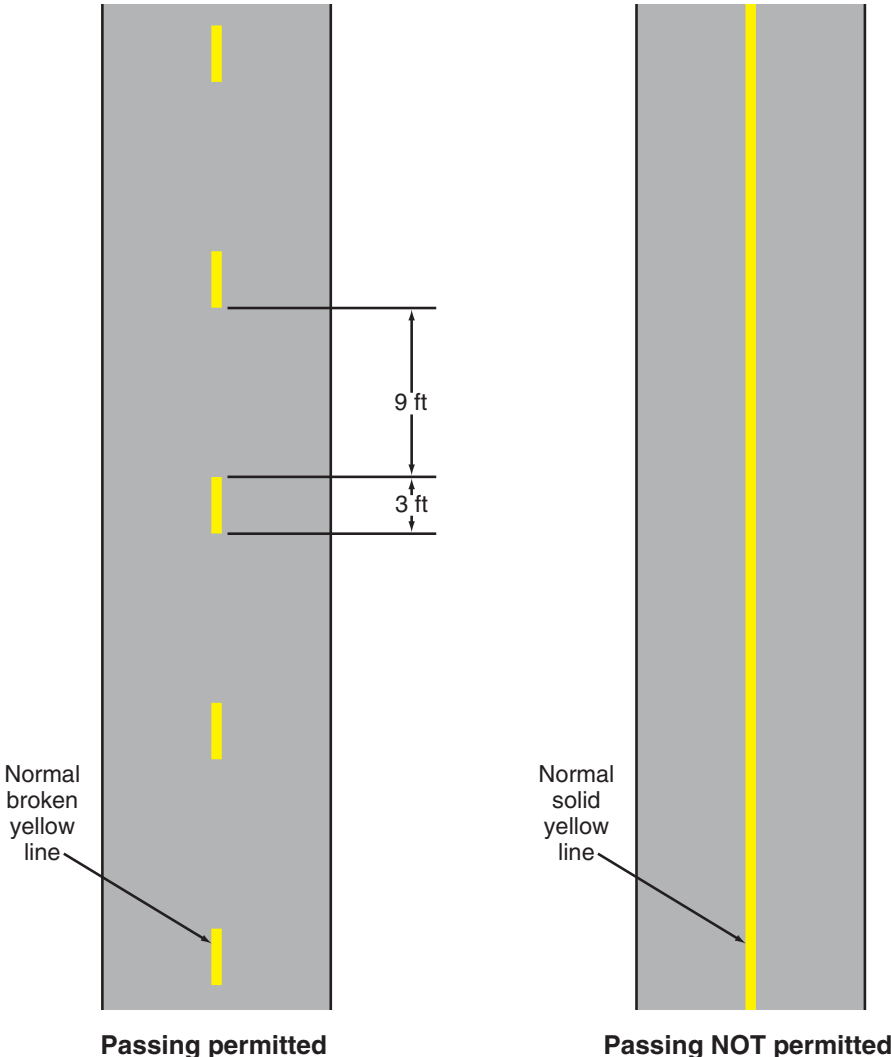


Type 3

**Figure 9C-1. Example of Intersection Pavement Markings—Designated Bicycle Lane with Left-Turn Area, Heavy Turn Volumes, Parking, One-Way Traffic, or Divided Highway**



**Figure 9C-2. Examples of Centerline Markings for Shared-Use Paths**



Fixed objects adjacent to shared-use paths may be marked with object markers (Type 1, 2, or 3).

**Standard:**

**All object markers shall be retroreflective.**

**Markers such as those described in Section 3C.01 shall also be used on shared-use paths, if needed.**

**Obstructions in the traveled way of a shared-use path shall be marked with retroreflectorized material or appropriate object markers.**

**On Type 3 markers, the alternating black and retroreflective yellow stripes shall be sloped down at an angle of 45 degrees toward the side on which traffic is to pass the obstruction.**

**Section 9C.04 Markings For Bicycle Lanes**

Guidance:

Longitudinal pavement markings should be used to define bicycle lanes.

Support:

Pavement markings designate that portion of the roadway for preferential use by bicyclists. Markings inform all road users of the restricted nature of the bicycle lane.

Examples of bicycle lane markings at right-turn lanes are shown in Figures 9C-1, 9C-3, and 9C-4. Examples of pavement markings for bicycle lanes on a two-way street are shown in Figure 9C-5. Pavement symbols and markings for bicycle lanes are shown in Figure 9C-6.

**Standard:**

**If used, the bicycle lane symbol marking (see Figure 9C-6) shall be placed immediately after an intersection and at other locations as needed. The bicycle lane symbol marking shall be white. If the bicycle lane symbol marking is used in conjunction with other word or symbol messages, it shall precede them.**

**If the word or symbol pavement markings shown in Figure 9C-6 are used, Bicycle Lane signs (see Section 9B.04) shall also be used, but the signs need not be adjacent to every symbol to avoid overuse of the signs.**

**A through bicycle lane shall not be positioned to the right of a right turn only lane.**

Support:

A bicyclist continuing straight through an intersection from the right of a right turn lane would be inconsistent with normal traffic behavior and would violate the expectations of right-turning motorists.

Guidance:

When the right through lane is dropped to become a right turn only lane, the bicycle lane markings should stop at least 100 ft. before the beginning of the right turn lane. Through bicycle lane markings should resume to the left of the right turn only lane.

An optional through-right turn lane next to a right turn only lane should not be used where there is a through bicycle lane. If a capacity analysis indicates the need for an optional through-right turn lane, the bicycle lane should be discontinued at the intersection approach.

Posts or raised pavement markers should not be used to separate bicycle lanes from adjacent travel lanes.

Support:

Using raised devices creates a collision potential for bicyclists by placing fixed objects immediately adjacent to the travel path of the bicyclist. In addition, raised devices can prevent vehicles turning right from merging with the bicycle lane, which is the preferred method for making the right turn. Raised devices used to define a bicycle lane can also cause problems in cleaning and maintaining the bicycle lane.

**Standard:**

**Bicycle lanes shall not be provided on the circular roadway of a roundabout intersection.**

**Section 9C.05 Bicycle Detector Symbol**

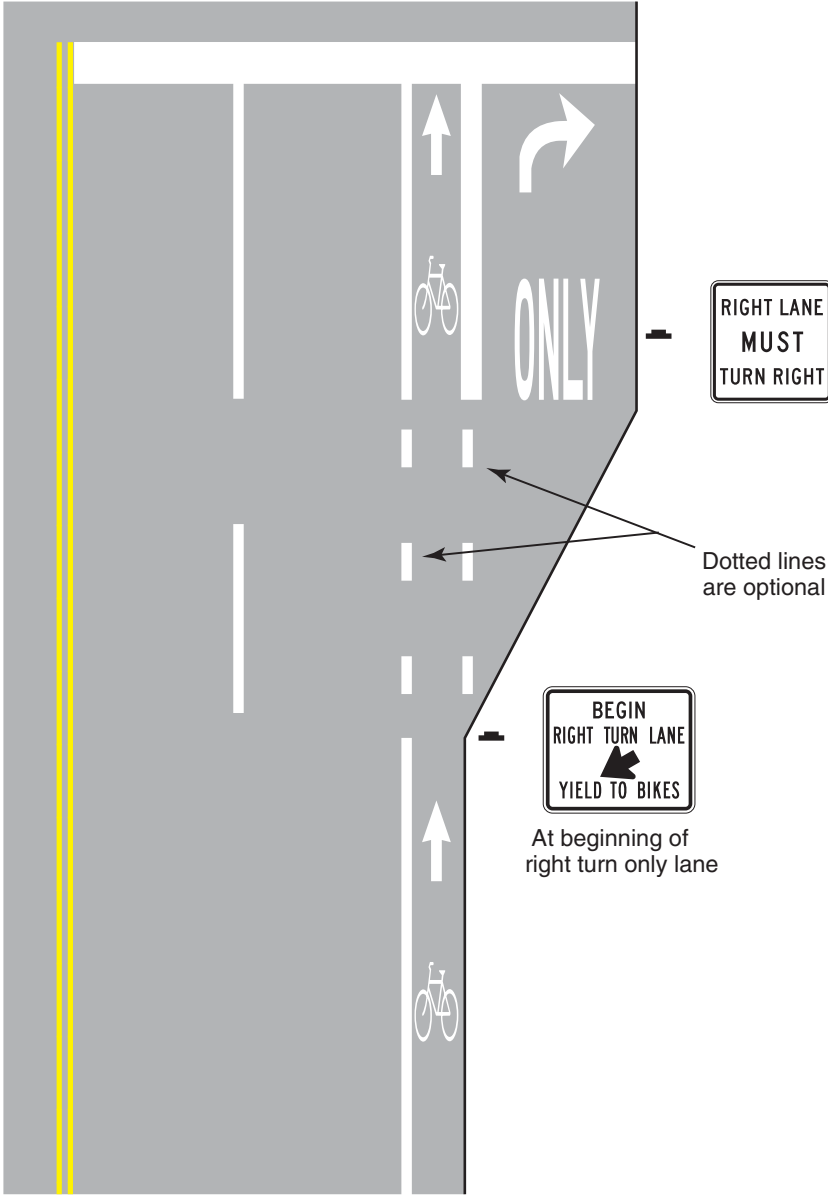
Option:

A symbol (see Figure 9C-7) may be placed on the pavement indicating the optimum position for a bicyclist to actuate the signal.

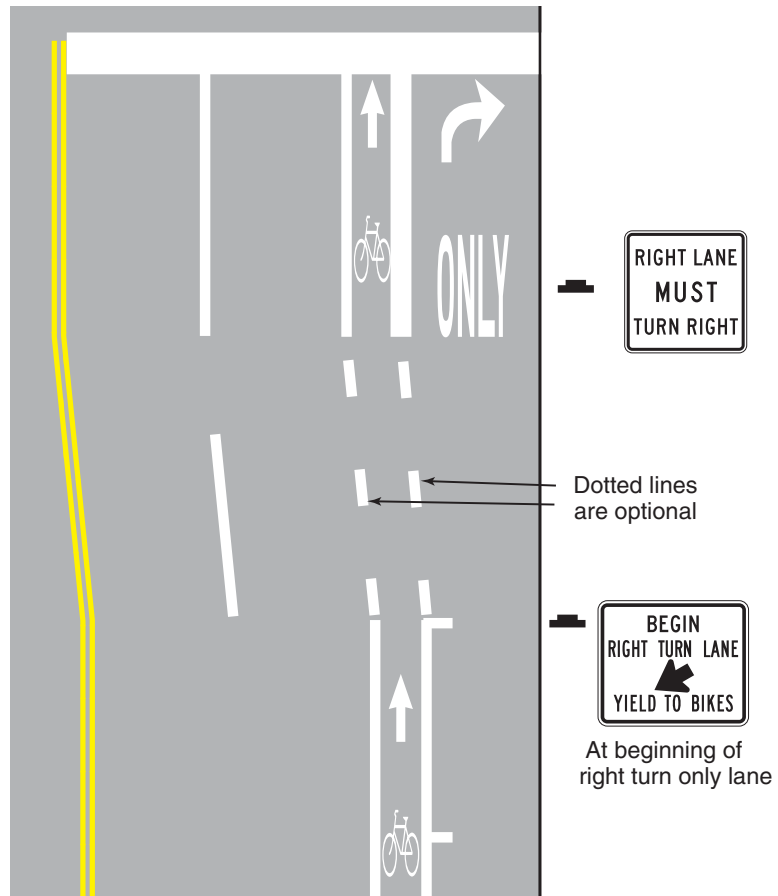
An R10-22 sign (see Section 9B.12 and Figure 9B-2) may be installed to supplement the pavement marking.



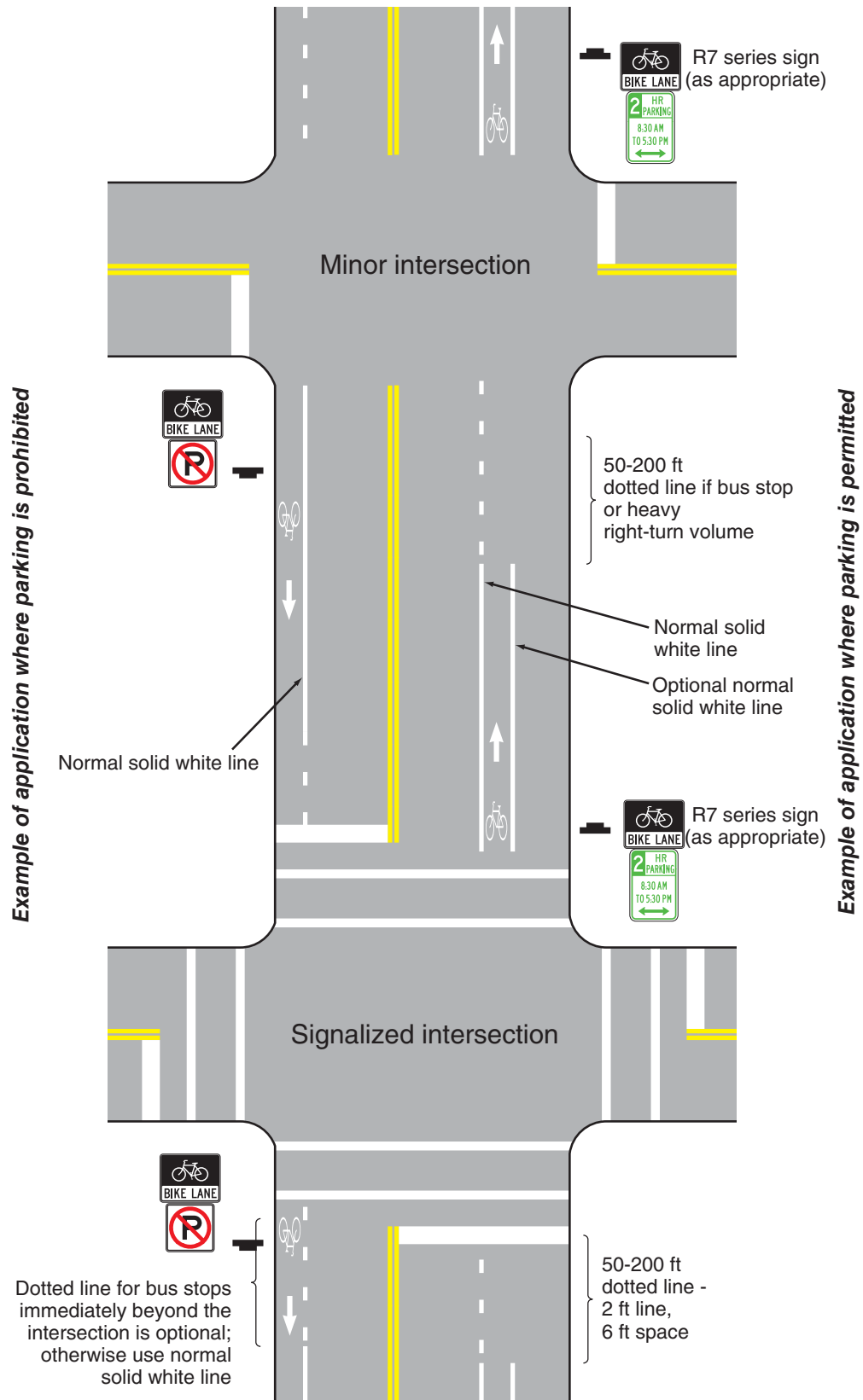
**Figure 9C-3. Example of Bicycle Lane Treatment at a Right Turn Only Lane**



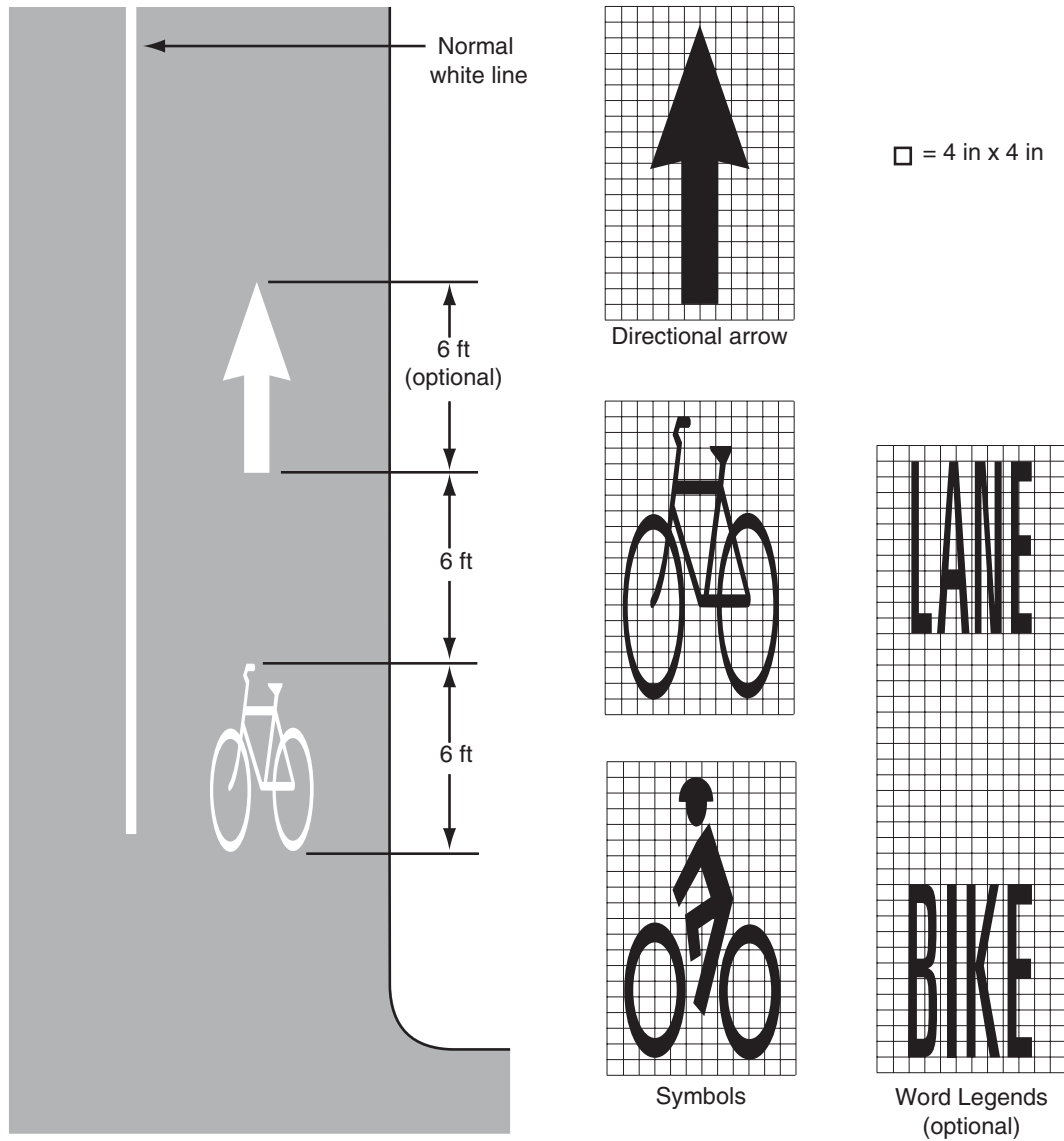
**Figure 9C-4. Example of Bicycle Lane Treatment at Parking Lane into a Right Turn Only Lane**



**Figure 9C-5. Example of Pavement Markings for Bicycle Lanes on a Two-Way Street**



**Figure 9C-6. Example of Optional Word and Symbol Pavement Markings for Bicycle Lanes**

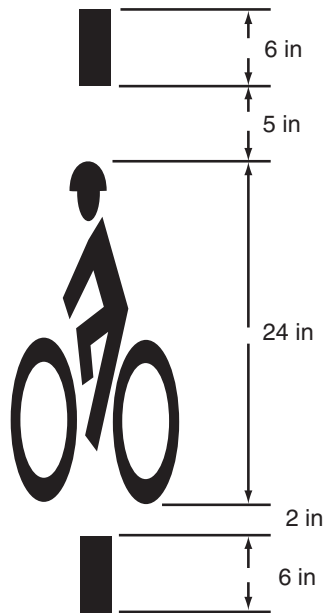


**Section 9C.06 Pavement Markings for Obstructions**

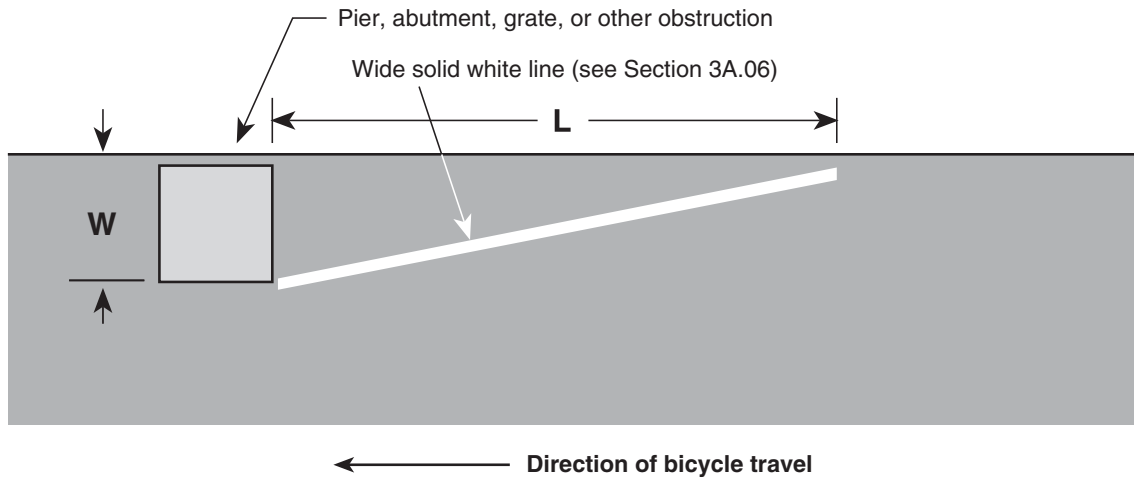
Guidance:

In roadway situations where it is not practical to eliminate a drain grate or other roadway obstruction that is inappropriate for bicycle travel, white markings applied as shown in Figure 9C-8 should be used.

**Figure 9C-7. Example of Bicycle Detector Pavement Marking**



**Figure 9C-8. Example of Obstruction Pavement Marking**



$L = WS$  , where S is bicycle approach speed in miles per hour



## CHAPTER 9D. SIGNALS

### **Section 9D.01 Application**

Support:

Part 4 contains information regarding signal warrants and other requirements relating to signal installations.

Option:

For purposes of signal warrant evaluation, bicyclists may be counted as either vehicles or pedestrians.

### **Section 9D.02 Signal Operations for Bicycles**

Standard:

**At installations where visibility-limited signal faces are used, signal faces shall be adjusted so bicyclists for whom the indications are intended can see the signal indications. If the visibility-limited signal faces cannot be aimed to serve the bicyclist, then separate signal faces shall be provided for the bicyclist.**

**On bikeways, signal timing and actuation shall be reviewed and adjusted to consider the needs of bicyclists.**

