



CITY OF DALLAS, TEXAS
DEPARTMENT OF TRANSPORTATION

TRAFFIC SIGN STANDARDS
JUNE 2021

APPROVED:

Ghassan Khankarli

GHASSAN KHANKARLI, P.E.
DIRECTOR

Jun 18, 2021

Date

GENERAL NOTES

1. THE EXISTING SIGNS LOCATED ON PUBLIC CONSTRUCTION SITES ARE THE PROPERTY OF THE CITY OF DALLAS. THROUGHOUT THE PERIOD OF THE CONTRACT, THE CONTRACTOR SHALL PROTECT THESE SIGNS SUCH THAT THEY ARE NOT DAMAGED IN THE COURSE OF CONSTRUCTION ACTIVITY.
2. PRIOR TO THE START OF CONSTRUCTION, ALL EXISTING SIGNS WITHIN THE AREA OF CONSTRUCTION WILL BE INVENTORIED AND DOCUMENTED JOINTLY BY THE CITY INSPECTOR AND THE CONTRACTOR. THIS DOCUMENT WILL BE JOINTLY SIGNED BY BOTH PARTIES REFLECTING THE SIGN TYPE, SIGN SIZE, SIGN CONDITION, SIGN LOCATION, REFLECTIVITY ADEQUACY, ETC. THE CONTRACTOR IS HELD ACCOUNTABLE FOR THESE SIGNS THROUGHOUT THE PROJECT AND AT THE COMPLETION OF THE PROJECT.
3. ALL GROUND MOUNTED AND OVERHEAD SIGNS SHALL USE ANSI STANDARD BQ1528 ALUMINUM BLANKS.
4. ALL BLANKS TO BE INSTALLED SHALL BE 5052-H38 ALUMINIUM (ASTM B -209).
5. THE THICKNESS FOR ALL SIGN BLANKS IS 0.080" EXCEPT OVERHEAD STREET NAME BLADES WHICH ARE 0.100".
6. ALL HOLES SHALL BE 3/8" DIAMETER DRILLED OR PUNCHED AS SHOWN ON EACH BLANK DETAIL AND SHALL BE FREE OF BURRS AND / OR ROUGH EDGES.
7. ALL SIGN FACE MATERIALS SHALL BE ASTM-4956 TYPE XI FULL CUBE PRISMATIC GRADE RETROREFLECTIVE SHEETING OR EQUIVALENT.
8. ALL STREETNAME SIGNS SHALL HAVE 1/4" DIAMETER HOLES DRILLED ON EACH END AND AFFIXED TOGETHER.
9. SIGN BLANK CORNERS TO BE ROUNDED AS SHOWN ON SHEET 5.
10. ALL SIGN BLANK ARE TO BE ETHCHED, DEGREASEODINE FINISH PRIOR TO APPLICATION OF LEGENDS.
11. ALL SIGNS SHALL BE MANUFACTURED AND INSTALLED IN CONFORMANCE TO THE LATEST CITY OF DALLAS SIGN STANDARDS.
12. A FULL LENGTH RED RETRO REFLECTIVE STRIP SHALL BE APPLIED TO STOP SIGN POSTS.
13. ALL ADVISORY SPEED SIGNS SHALL BE BASED ON AN ENGINEERING STUDY, PLEASE FOLLOW TXDOT PROCEDURES FOR ESTABLISHING SPEED ZONES. THE PROCEDURES ARE AVAILABLE AT <http://onlinemanuals.txdot.gov/txdotmanuals/szn/szn.pdf>.
14. ALL SCHOOL ZONE WARNING SIGNS SHALL HAVE FLUORESCENT YELLOW GREEN BACKGROUNDS.
15. IF A TRAFFIC SIGN IS NOT SHOWN ON SHEETS 6 & 7, REFER TO STANDARD HIGHWAY SIGN DESIGNS FOR TEXAS AVAILABLE AT <https://www.txdot.gov/inside-txdot/forms-publications/publications/highway-signs.html> OR CONTACT TRANSPORTATION PROJECT COORDINATOR II AT 214-671-8021 FOR GUIDANCE.
16. ALL DETAILS ARE NOT TO SCALE.

TYPICAL GROUND SIGN INSTALLATION PERFORATED SQUARE METAL TUBING

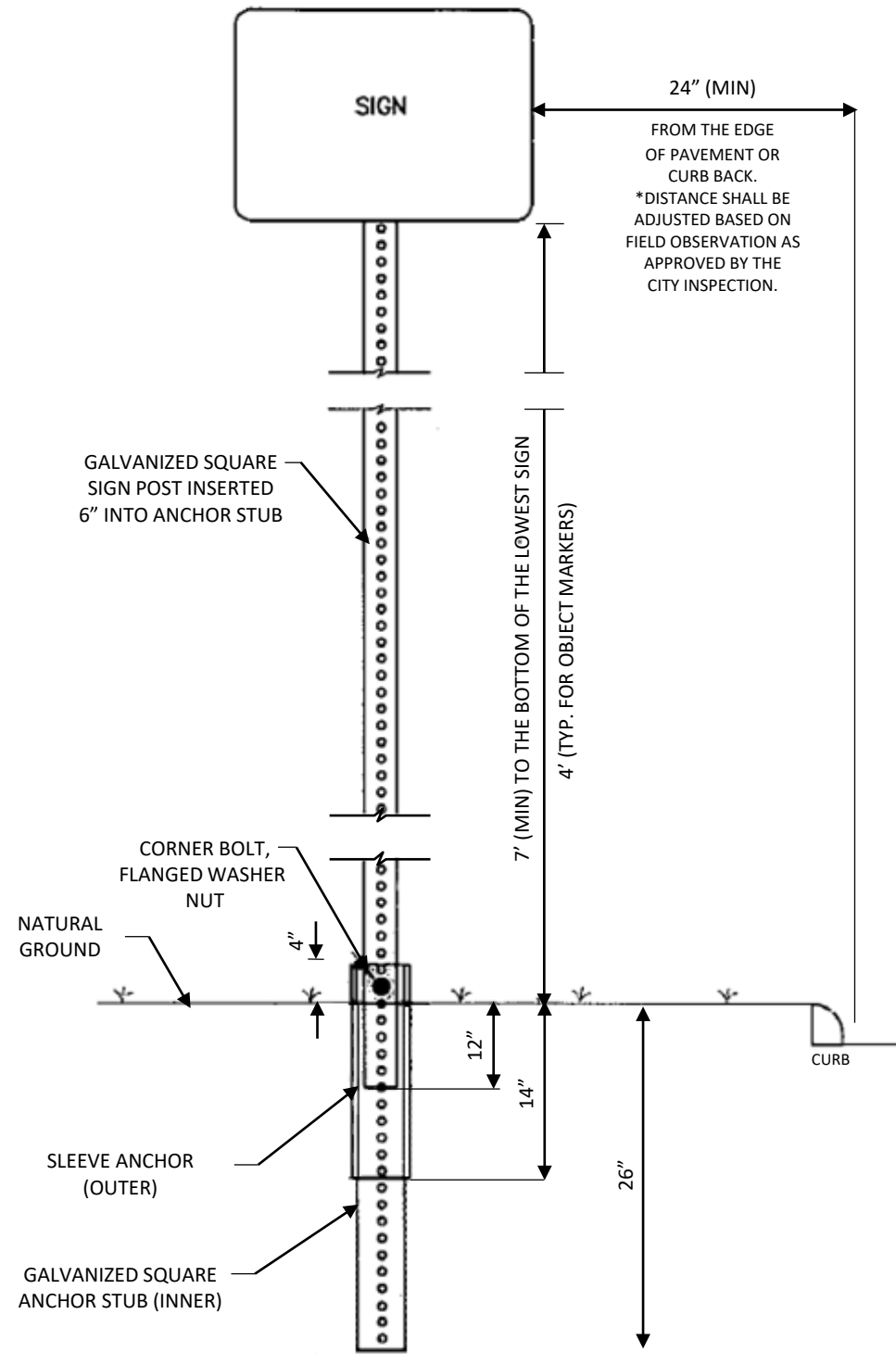

TYPICAL STOP SIGN AND STREET NAME SIGN INSTALLATION

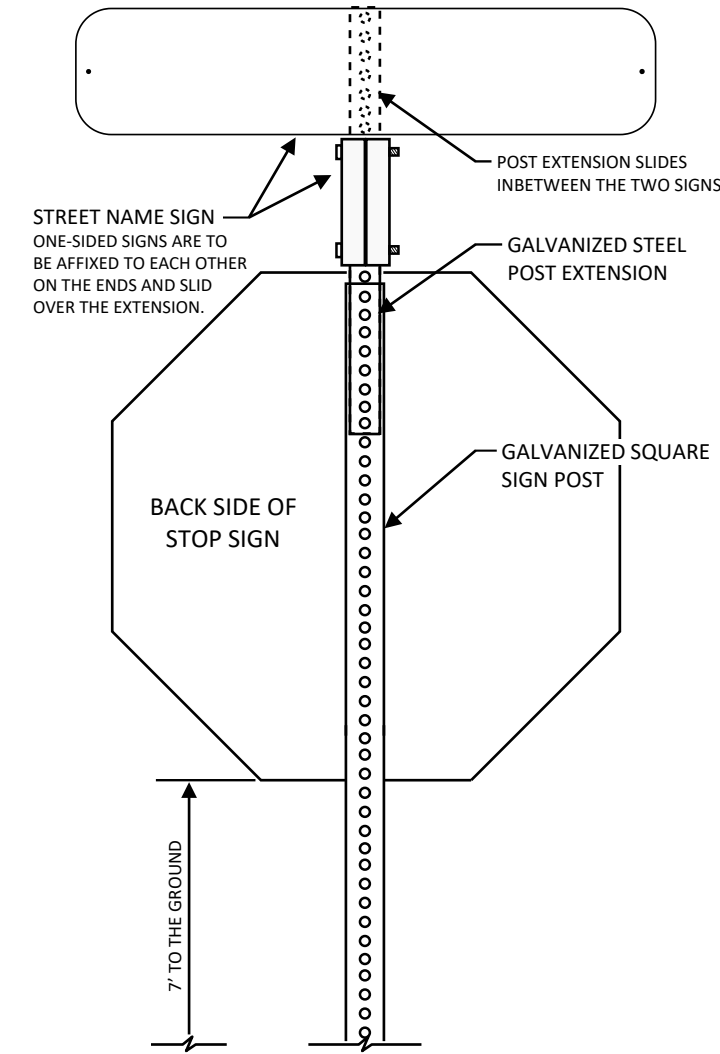

SLEEVE DETAILS	
GALVANIZED SQUARE SIGN POST EXTENSION (PERFORATED)	1-1/2" x 1-1/2" (14 GAUGE)
GALVANIZED SQUARE SIGN POST (PERFORATED)	1-3/4" x 1-3/4" (14 GAUGE)
GALVANIZED SQUARE SIGN POST (PERFORATED) (INNER)	2" x 2" x 30" (14 GAUGE)
GALVANIZED SQUARE SIGN POST (PERFORATED) (OUTER)	2 1/4" x 2 1/4" x 18" (14 GAUGE)

D3-1 GROUND MOUNTING DETAIL

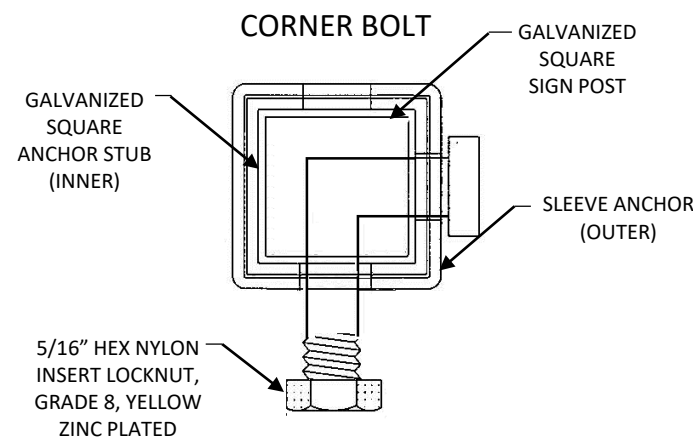
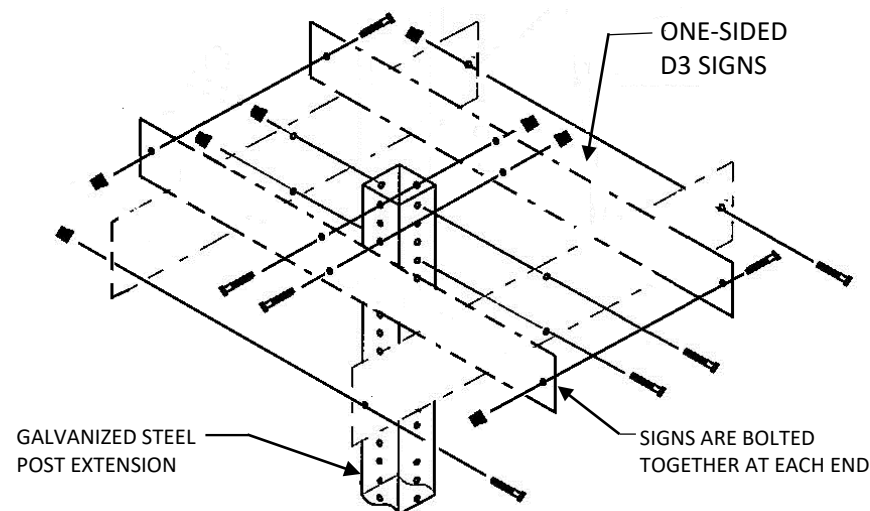

CITY OF DALLAS
DEPARTMENT OF TRANSPORTATION

GENERAL NOTES & TRAFFIC SIGN MOUNTING DETAILS

APPROVED BY: GHASSAN KHANKARLI, P.E.	EFF DATE: June 2021	SHEET 1
---	------------------------	-------------------

TYPICAL HARD SURFACE INSTALLATION GALVANIZED SIGN BASE
 (USED ONLY WHEN UNDERGROUND CONDITIONS PROHIBIT USE OF STANDARD ANCHOR SLEEVE
 - APPROVAL FROM TRANSPORTATION OPERATIONS STAFF NEEDED PRIOR TO USE)

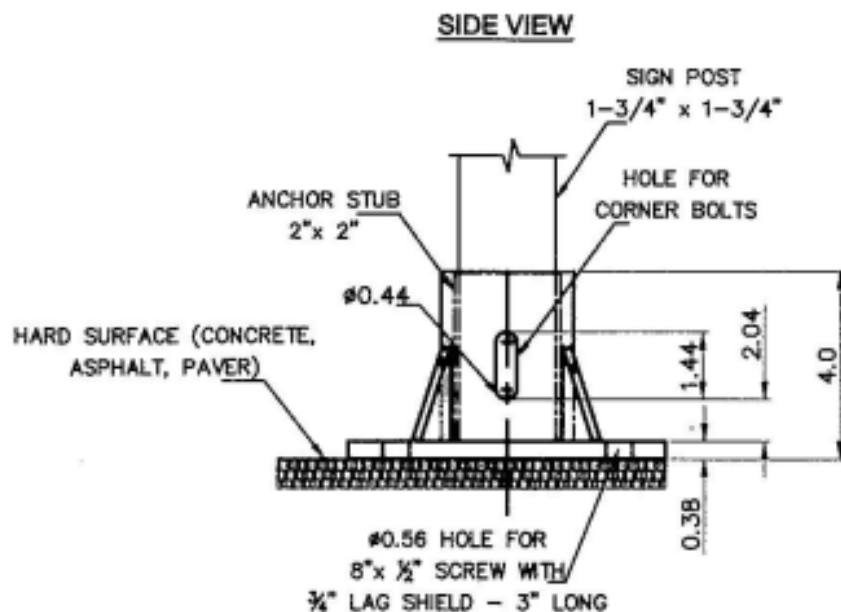
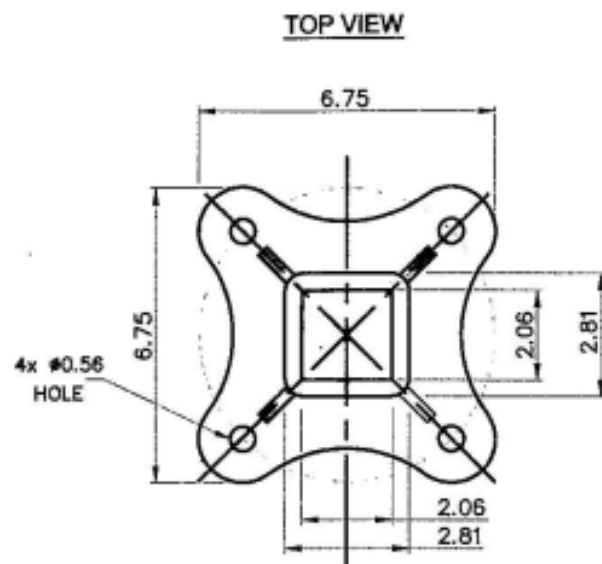

1/2" FLAT WASHERS, LOW CARBON, SAE, ZINC PLATED

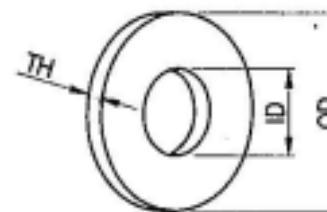

SAE FLAT WASHERS									
SIZE	ID			OD			THICKNESS--TH		
	BASIC	TOLERANCE		BASIC	TOLERANCE		BASIC	PLUS	MINUS
		PLUS	MINUS		PLUS	MINUS			
1/2	0.515	0.015	0.005	1.062	0.030	0.007	0.095	0.121	0.074

DIMENSIONS: ASME B18.21.1, TYPE A PLAIN WASHERS
 MATERIAL: CARBON STEEL
 FINISH: Fe/Zn 3AT PER ASTM F1941

- NOTES:**
1. MATERIAL: ASTM A-536 GRADE 65-45-12 DUCTILE IRON
 2. HOT DIP GALVANIZE PER ASTM A-153
 3. ALL DIMENSIONS ARE IN INCHES

HEX NYLON INSERT LOCKNUTS (NE), GRADE 8, YELLOW ZINC PLATED

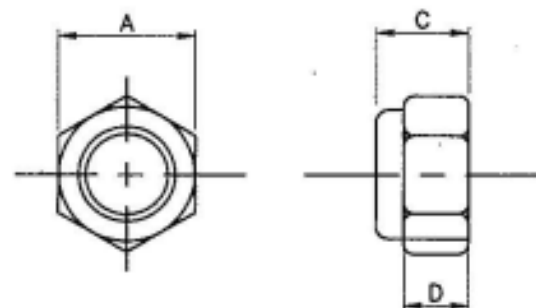

SIZE	C		A		D
	THICKNESS		WIDTH ACROSS FLATS		HEX HEIGHT
	MAX	Min	MAX	Min	Min
5/16	0.359	0.329	0.502	0.489	0.250

DIMENSIONS: ASME B18.16.6
 MATERIAL: CARBON STEEL, GRADE 8 PER ASME B18.16.6, NYLON 6/6
 THREAD REQUIREMENTS: ASME B1.1 UNC& UNF CLASS 2B

ANCHOR LAG SHIELD - ZINC ALLOY

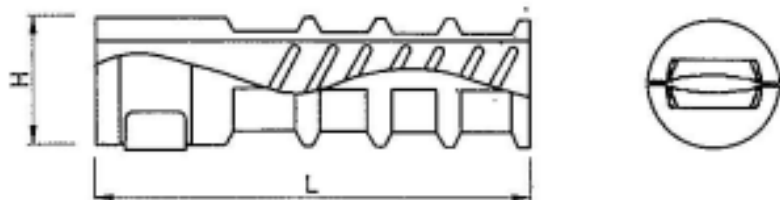

TH	L		H
LAG THREAD SIZE	LENGTH		DRILLED HOLE SIZE
	NOMINAL		
1/2"	2"	3"	3/4"

8" HEX LAG SCREWS, HOT DIPPED GALVANIZED

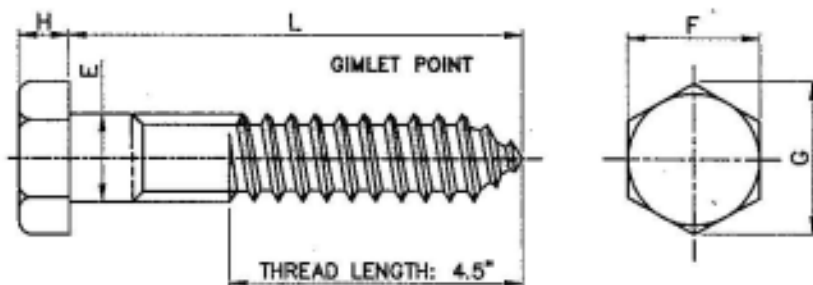

DIAMETER	E		F		G		H		L
	BODY DIAMETER		WIDTH ACROSS FLATS		WIDTH ACROSS CORNERS		HEIGHT		
	MAX.	MIN.	MAX.	MIN.	MAX.	MIN.	MAX.	MIN.	
1/2	0.515	0.482	0.750	0.725	0.866	0.826	0.364	0.302	8

MATERIAL: PER A307 GRADE A
 COATING: HOT DIP ZINC PER ASTM F2329 OR IN ACCORDANCE WITH CLASS C OF ASTM A153 AND CLASS D FOR 3/8" DIAMETER AND LESS

CITY OF DALLAS DEPARTMENT OF TRANSPORTATION		
TRAFFIC SIGN BASE DETAILS		
APPROVED BY: GHASSAN KHANKARLI, P.E.	EFF DATE: June 2021	SHEET 2

D3-1 STREET NAME SIGN EXAMPLES
(DIMENSIONS SHOWN ARE TYPICAL)

D3-1 STREET NAME SIGN

HEIGHT	9" SIGN BLANK (9.30" DESIGNED WITH FULL BLEED)
LENGTH	30", 36" 42" OR 48"
THICKNESS	0.080"
SUBSTRATE	ALUMINUM ALLOY, 5052-H38 (ASTM B-209)
SIGN FACE MATERIAL	GREEN FILM OVER ASTM-4956 TYPE XI FULL CUBE PRISMATIC GRADE RETROREFLECTIVE SHEETING OR EQUIVALENT
SIGN FONT	CLEARVIEW HWY 3W
COLOR	LETTERS - WHITE REFLECTIVE BACKGROUND – GREEN FILM

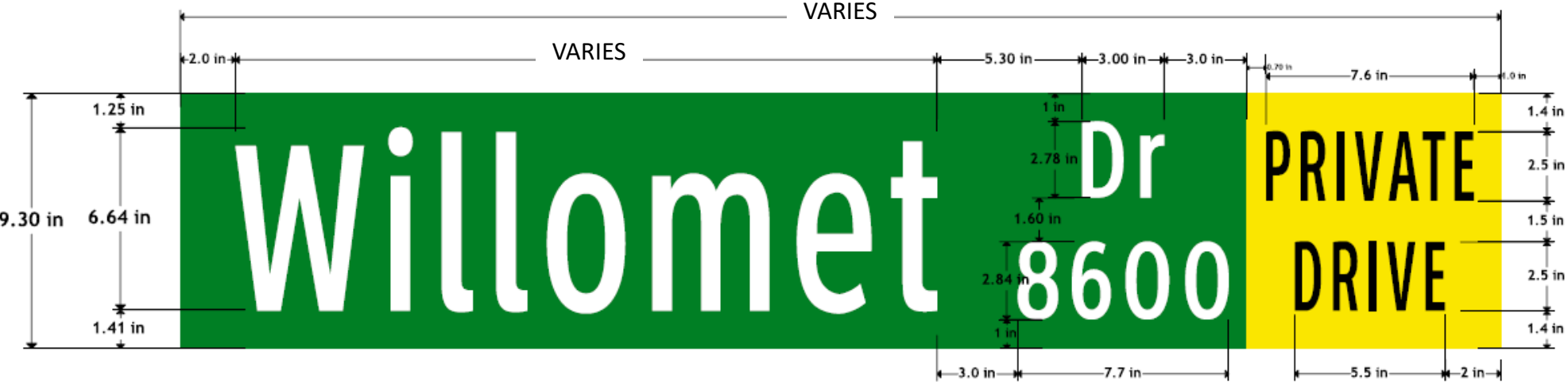
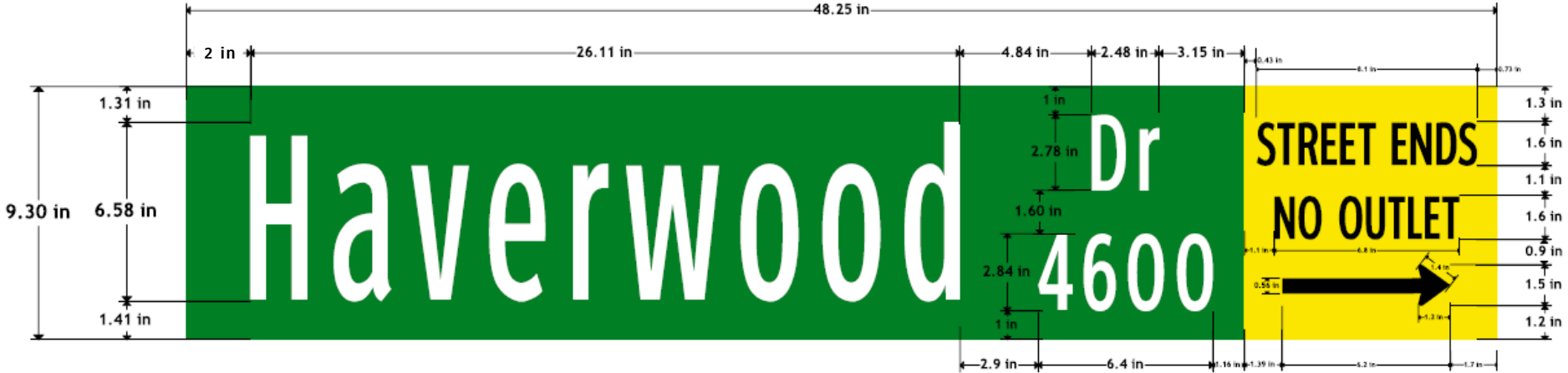

D3-1 STREET NAME SIGN DIMENSIONS

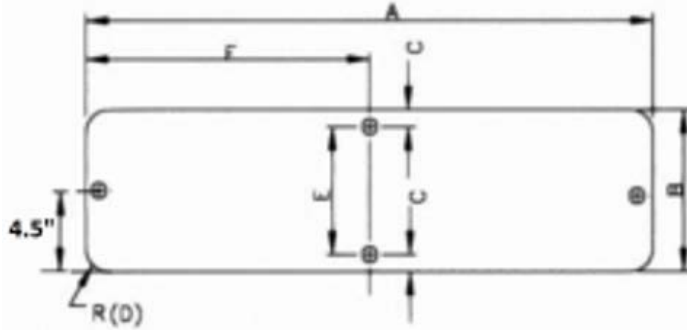

TABLE - D3 SIGN

A	B	C	D	E	F
30	9	1 1/2	3/4	6	15
36	9	1 1/2	3/4	6	18
42	9	1 1/2	3/4	6	21
48	9	1 1/2	3/4	6	24

- NOTES:
1. TEXT SHALL START 2" FROM THE LEFT EDGE
 2. STREETNAME SHALL BE CENTERED
 3. 1" MIN. SPACE BETWEEN STREET NAME LETTERS
 4. SUFFIX AND BLOCK NUMBER MUST BE LOCATED 2" FROM STREET NAME AND 2" FROM THE RIGHT EDGE, SUFFIX AT TOP AND BLOCK NUMBER AT BOTTOM, 3" SPACE BETWEEN THEM.
 5. LETTERS AND/OR NUMBERS SPACES IN THE SUFFIX AND BLOCK NUMBER MUST BE 1.5" MIN
 6. BLOCK NUMBER MUST HAVE 1" SPACE FROM THE BLADE EDGE
 7. ALL DIMENSIONS ARE IN INCHES.
 8. SIGN LENGTH WILL BE DICTATED BY THE NUMBER OF LETTERS IN THE NAME
 9. ALL STREETNAME SIGNS SHALL HAVE 1/4" DIAMETER HOLES DRILLED ON EACH END AND AFFIXED TOGETHER.

CITY OF DALLAS DEPARTMENT OF TRANSPORTATION		
GROUND MOUNTED STREET NAME BLADE (D3-1) DETAILS		
APPROVED BY: GHASSAN KHANKARLI, P.E.	EFF DATE: June 2021	SHEET 3A

D3-1 OVERHEAD SIGN PANEL DIMENSIONS

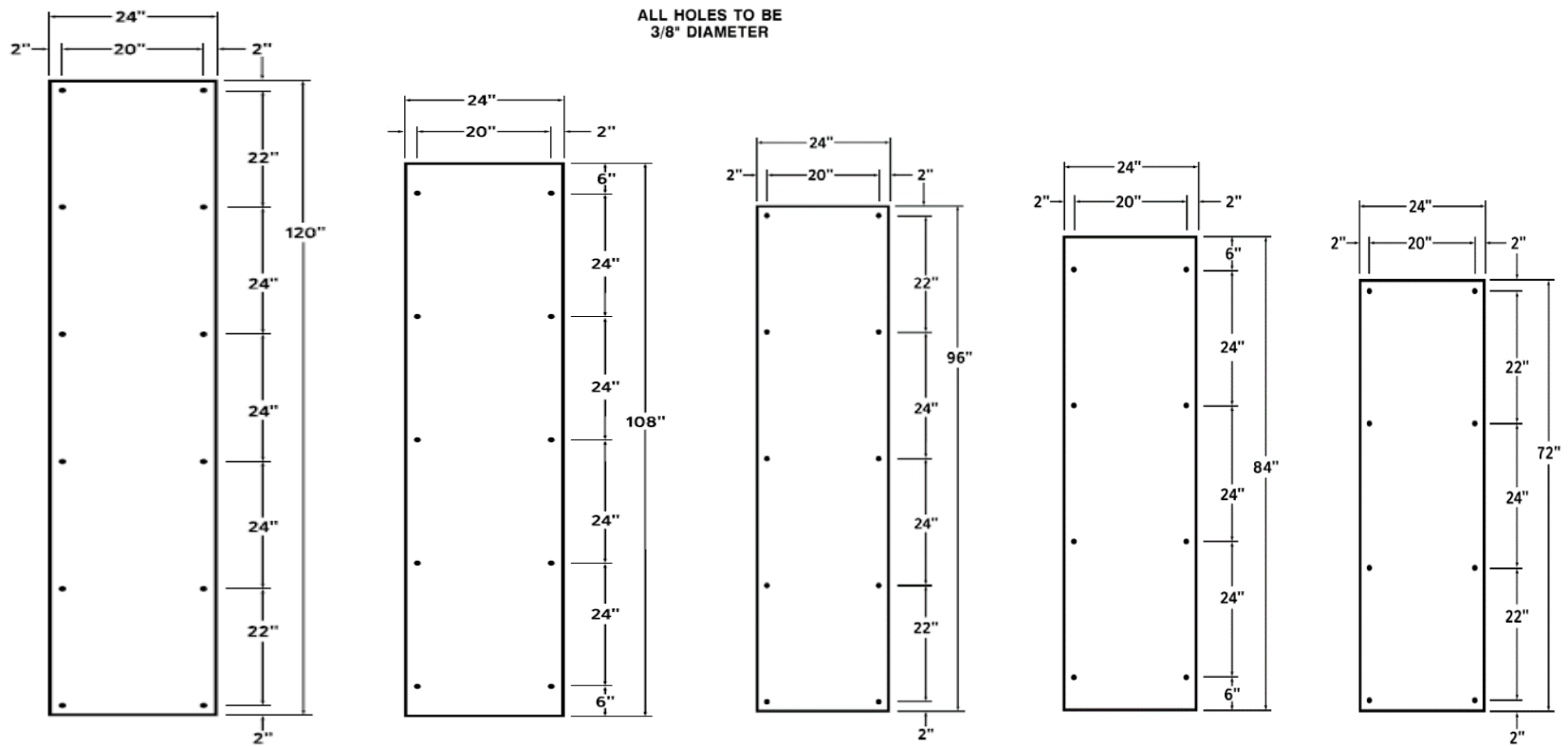

HEIGHT	24"
LENGTH	72", 84", 96", 108", or 120"
THICKNESS	0.100"
SUBSTRATE	ALUMINUM ALLOY, 5052-H38 (ASTM B-209)
SIGN FACE MATERIAL	GREEN FILM OVER ASTM-4956 TYPE XI FULL CUBE PRISMATIC GRADE RETROREFLECTIVE SHEETING OR EQUIVALENT
SIGN FONT	CLEARVIEW HWY 5W
COLOR	LETTERS - WHITE REFLECTIVE BACKGROUND - GREEN FILM

DETAILS FOR MOUNTING TRAFFIC SIGNS ON SIGNAL MAST ARMS AND POLES

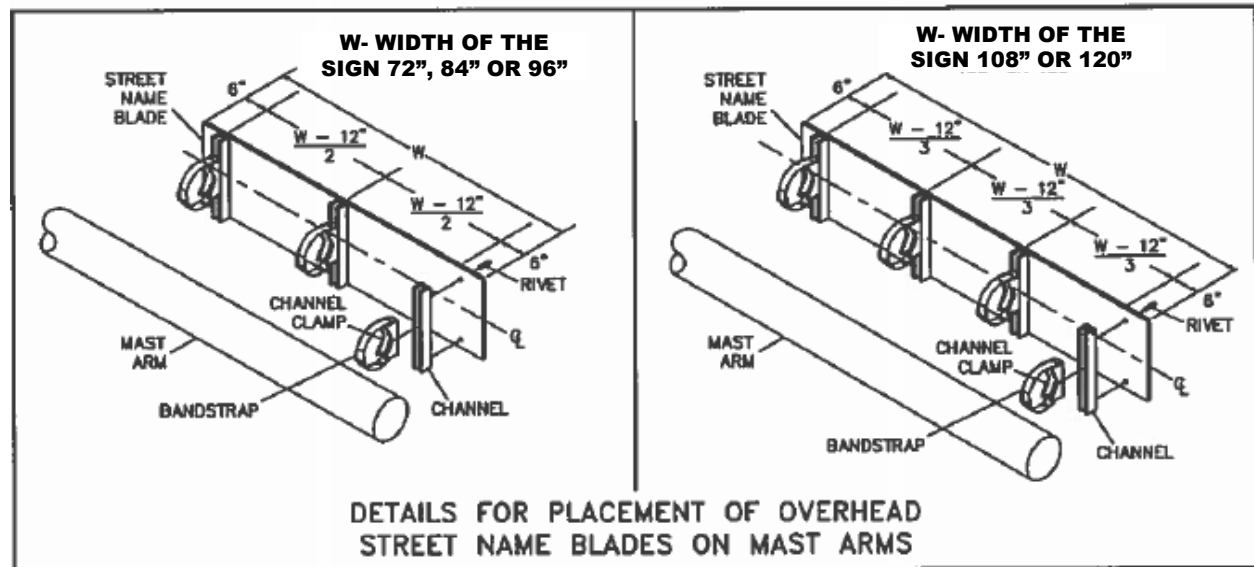

D3-1 OVERHEAD STREET NAME SIGN EXAMPLES (DIMENSIONS SHOWN ARE TYPICAL)

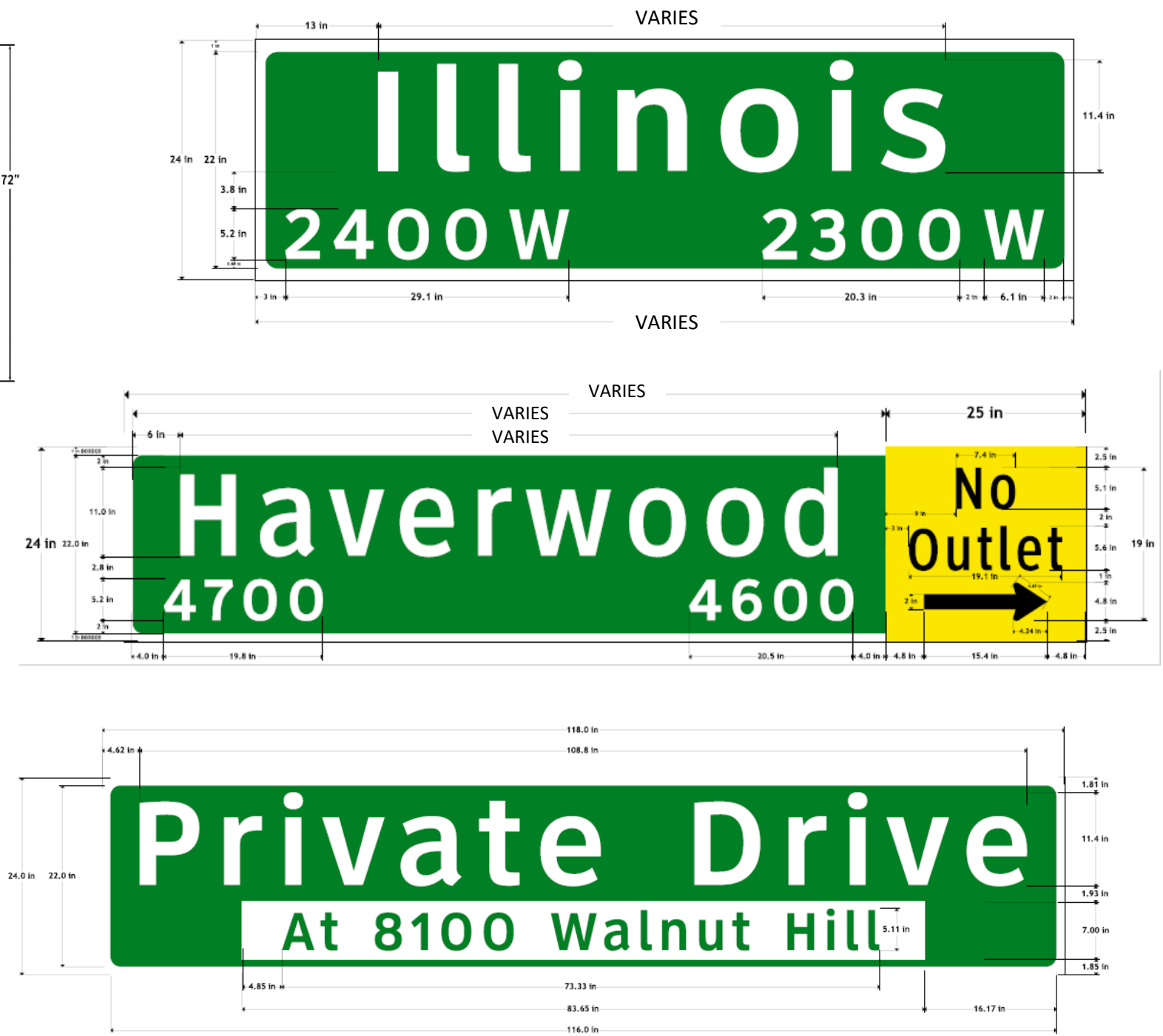

NOTE: SIGN LENGTH WILL BE DICTATED BY THE NUMBER OF LETTERS IN THE NAME. THE HEIGHT SHALL BE 24"

CITY OF DALLAS
DEPARTMENT OF TRANSPORTATION
OVERHEAD STREET NAME BLADE (D3-1) DETAILS

APPROVED BY: GHASSAN KHANKARLI, P.E.	EFF DATE: June 2021	SHEET 3B
---	------------------------	-------------

TWO-WAY STOP CONTROL INTERSECTION

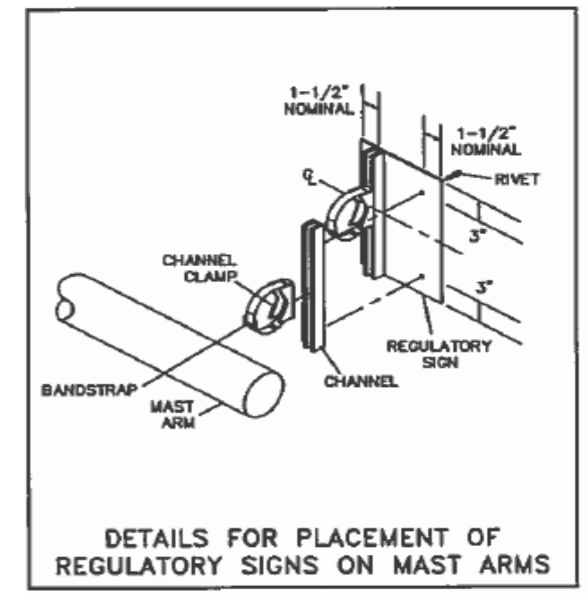
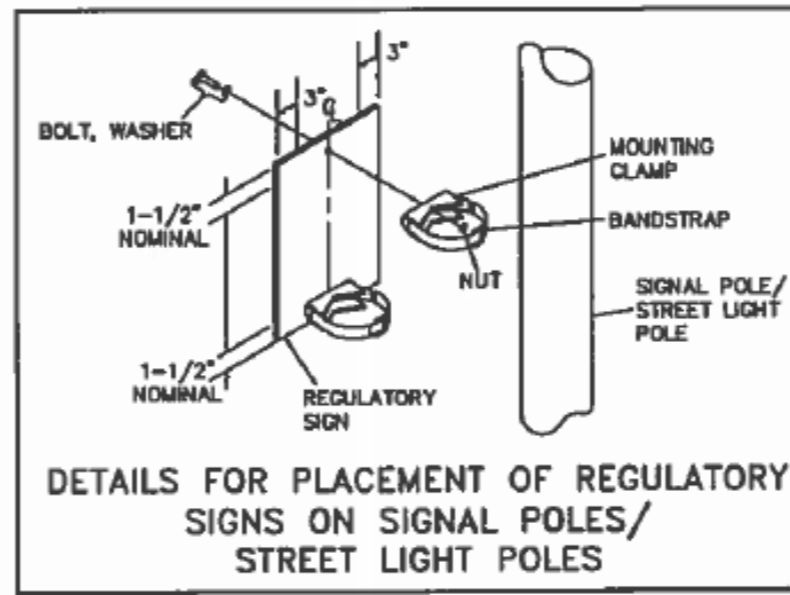
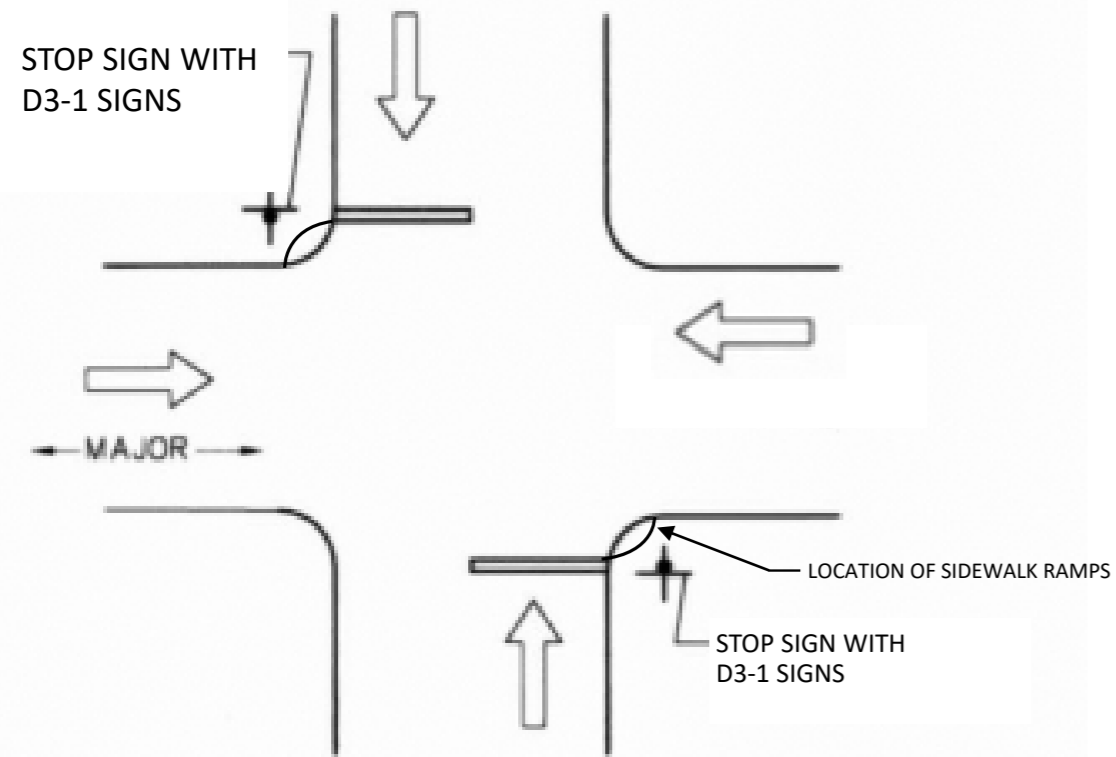

**STOP SIGNS ARE TO BE INSTALLED IN ADVANCE OF CROSSWALK AND RAMP

ALL-WAY STOP CONTROL INTERSECTION

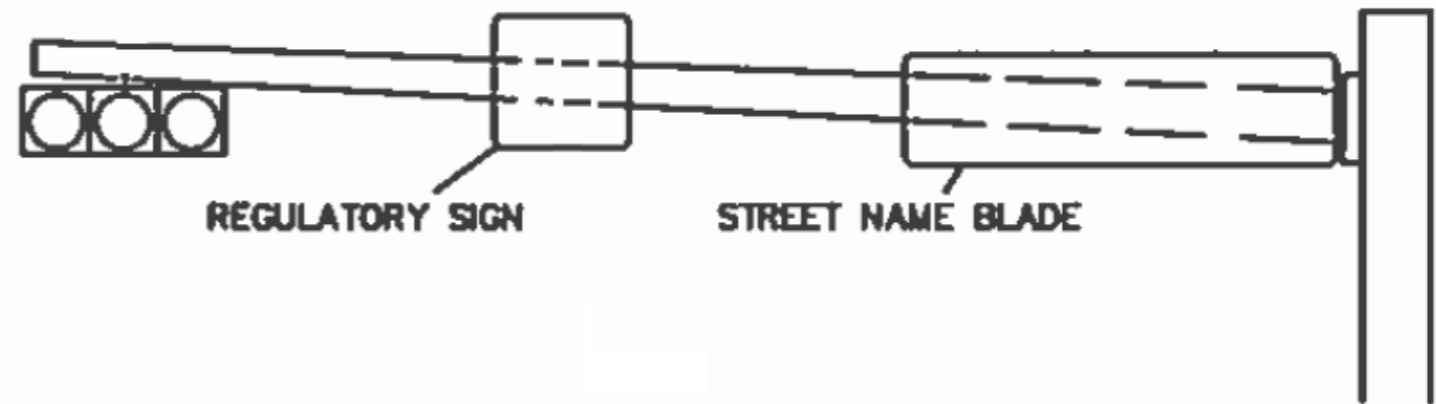
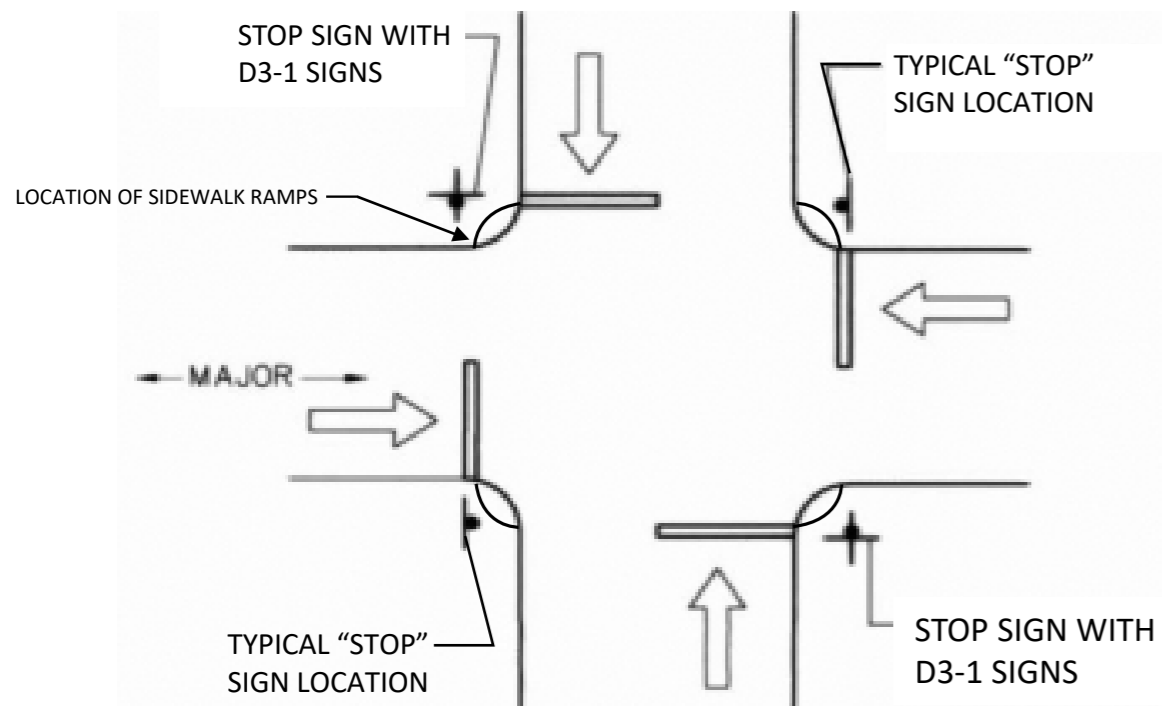

TYPICAL SIGN PLACEMENTS ON SIGNAL MAST ARMS

CITY OF DALLAS DEPARTMENT OF TRANSPORTATION		
TYPICAL STREET NAME SIGN PLACEMENTS		
APPROVED BY: GHASSAN KHANKARLI, P.E.	EFF DATE: June 2021	SHEET 4

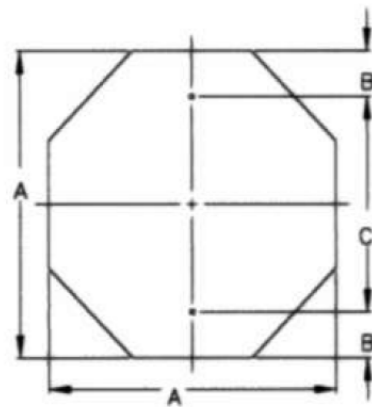

OCTAGONAL

A	B	C	T
36	3	30	0.080

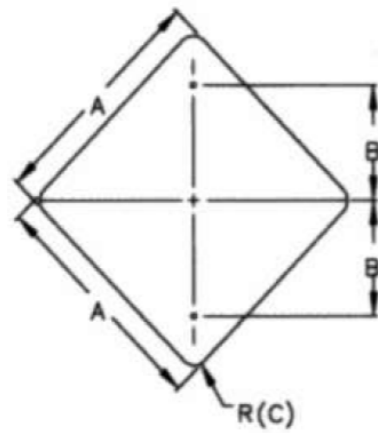

DIAMOND

A	B	C	T
24	12	1½	0.080
30	15	1½	0.080
36	18	2¼	0.080

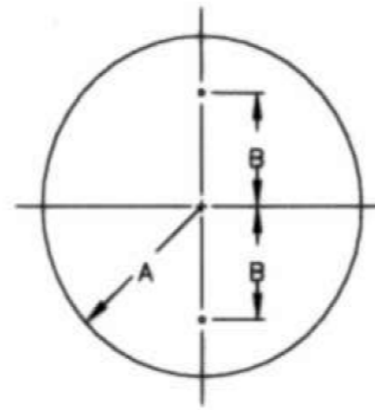

CIRCLE

A	B	T
15	15	0.080
18	12	0.080

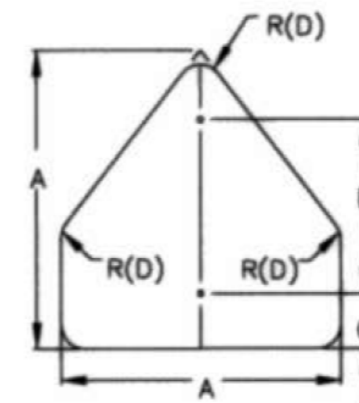

PENTAGON (SCHOOL)

A	B	C	D	T
36	24	3	2¼	0.080

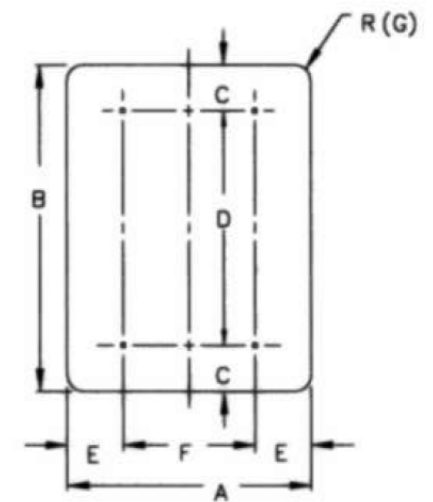

VERTICAL RECTANGLE

A	B	C	D	E	F	G	T
36	48	6	36	6	24	2¼	0.080
48	60	6	48	9	30	3	0.080

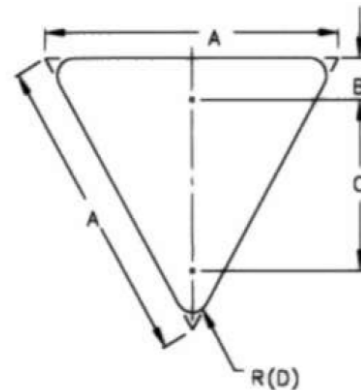

EQUILATERAL TRIANGLE

A	B	C	D	T
36	3	21	2	0.080

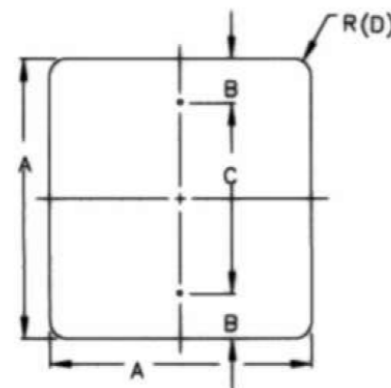

SQUARE (A)

A	B	C	D	T
18	3	12	1½	0.080
24	3	18	1½	0.080
30	3	24	1½	0.080

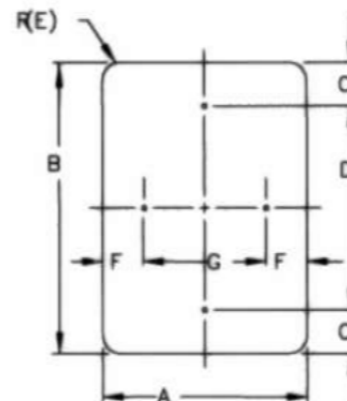

VERTICAL / HORIZONTAL RECTANGLE

A	B	C	D	E	F	G	T
12	18	1½	15	1½	1½	9	0.080
12	36	3	30	1½	1½	9	0.080
18	24	3	18	1½	1½	15	0.080
24	30	3	24	1½	3	18	0.080
24	36	3	30	1½	3	18	0.080
24	48	6	36	1½	3	18	0.080
30	36	3	30	1½	3	24	0.080

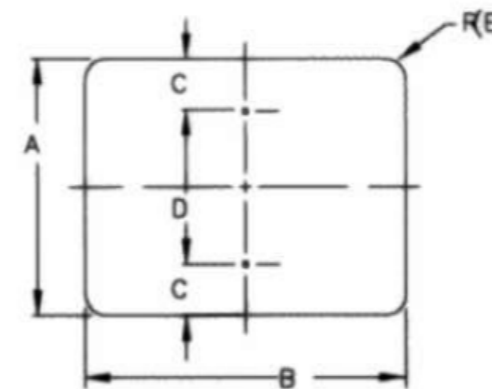

HORIZONTAL RECTANGLE

A	B	C	D	E	T
24	12	1½	9	1½	0.080
24	18	3	12	1½	0.080
30	24	3	18	1½	0.080
36	12	1½	9	1½	0.080

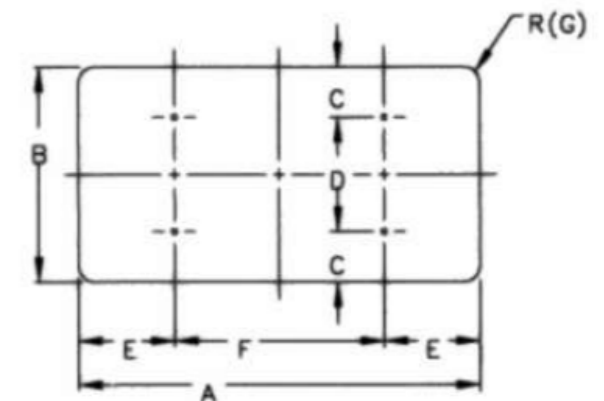

HORIZONTAL RECTANGLE

A	B	C	D	E	F	G	T
36	24	3	18	6	24	1½	0.080
48	24	3	18	9	30	1½	0.080
48	36	6	24	9	30	2¼	0.080
60	24	3	18	12	36	1½	0.080
60	36	6	24	12	36	2¼	0.080

NOTES:
 ALL DIMENSIONS ARE IN INCHES
 R () – RADIUS OF THE ROUNDED CORNER
 T – THICKNESS OF SIGN BLANK

CITY OF DALLAS DEPARTMENT OF TRANSPORTATION		
TRAFFIC SIGN BLANK DIMENSIONS		
APPROVED BY: GHASSAN KHANKARLI, P.E.	EFF DATE: June 2021	SHEET 5

REGULATORY SIGNS

THESE SIGNS REQUIRE A CLEAR ULTRAVIOLET AND ANTI-GRAFFITI PROTECTIVE FILM



36"
R1-1
500



18" x 6"
R1-3P
002



36"
R1-2
501



30" x 30"
R5-1
189



24" x 30"
R10-11
105 M



24" x 24"
R3-1
097



24" x 24"
R3-2
098



24" x 24"
R3-4
107



24" x 24"
R9-3
102



24" x 24"
R5-2
120

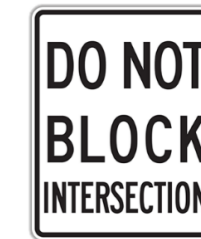

24" x 30"
R10-7
116 M



24" x 12"
079



30" x 36"
197



30" x 36"
198



30" x 36"
R3-5L
142 M



30" x 36"
R3-5R
143 M



24" x 36"
R3-9B
196 M



30" x 30"
R3-8L
139



24" x 30"
R10-5M
220



24" x 30"
R2-1-30
122



24" x 30"
R2-1-35
123



24" x 30"
R2-1-40
124



24" x 30"
R2-1-45
126

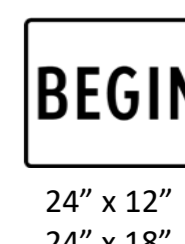

24" x 12"
24" x 18"
M4-14
084



24" x 30"
R6-2V
127



24" x 30"
R6-2R
128



24" x 30"
R6-2L
129



24" x 30"
R10-6aR
131



24" x 30"
R10-6aL
132



18" x 12"
R9-3bPL
038



18" x 12"
R9-3bPR
039



18" x 24"
R4-7
051



30" x 30"
R6-5P



30" x 24"
48" x 24"
60" x 24"
R6-4, R6-4a
R6-4b



12" x 24"
258



12" x 12"
221



12" x 24"
226



12" x 24"
229



12" x 24"
225

SCHOOL SIGNS



24" x 48"
S5-1
256



30"
S1-1
400



36"
S1-1
410

USE WHEN ROADWAY HAS 6 OR MORE LANES



24" x 12"
SW16-9P
401 M



24" x 24"
099



24" x 12"
SW16-7PL(R)
402



30" x 18"
SW16-7PL(R)
412

(USE WITH SIGN S1-1, 410)

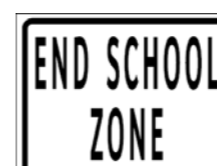

24" x 10"
30" x 12"
36" x 18"
S5-2aTP
086

IF A TRAFFIC SIGN IS NOT SHOWN HERE, REFER TO *STANDARD HIGHWAY SIGN DESIGNS FOR TEXAS* AVAILABLE AT <https://www.txdot.gov/inside-txdot/forms-publications/publications/highway-signs.html> OR CONTACT TRANSPORTATION OPERATIONS STAFF AT 214-670-6904 FOR GUIDANCE.

USE FLOURESCENT YELLOW / GREEN BACKGROUND FOR SIGNS 256, 400, 410, 401, 402, 412
REFER TO *STANDARD HIGHWAY SIGN DESIGNS FOR TEXAS* FOR COLOR DETAILS

LEGEND

24" x 18" - SIZE

S4-1D - TMUTCD (TEXAS MANUAL OF UNIFORM TRAFFIC CONTROL DEVICES) CODE

081 - DALLAS SIGN INVENTORY CODE

CITY OF DALLAS
DEPARTMENT OF TRANSPORTATION

TRAFFIC SIGN LEGENDS AND IDENTIFICATION CODES

APPROVED BY: GHASSAN KHANKARLI, P.E.	EFF DATE: June 2021	SHEET 6
---	------------------------	------------

WARNING SIGNS

USE FLUORESCENT YELLOW BACKGROUND



30" x 30"
W3-3
155



30" x 30"
W3-1
159



30" x 30"
W4-2L
140



30" x 30"
W4-2R
141



30" x 30"
W6-3
161



30" x 30"
W1-1R
177



30" x 30"
W1-1L
178



30" x 30"
W1-2L
184



30" x 30"
36" x 36"
W2-6aT



30" x 30"
W1-2R
185



30" x 30"
W2-2L(R)
191



30" x 30"
W2-1
194



30"
W10-1
150



24" x 18"
W10-9P
154



24" x 12"
W16-9P
080



18" x 24"
W1-8(L)(R)
056



30" x 30"
W6-1
188



30" x 30"
36" x 36"
W2-6



18" x 24"
072



24" x 24"
W13-20
093



24" x 24"
W13-25
094



24" x 24"
W13-30
095



24" x 12"
W4-4P
219



48" x 24"
W1-6L(R)
211



48" x 24"
W1-7
212



24" x 18"
W16-12P



30" x 30"
W11-2
147

USE FLOURESCENT
YELLOW / GREEN BACKGROUND



24" x 12"
W16-17P

LEGEND

24" x 18" - SIZE

S4-1D - TMUTCD (TEXAS MANUAL OF UNIFORM TRAFFIC CONTROL DEVICES) CODE

081 - DALLAS SIGN INVENTORY CODE

IF A TRAFFIC SIGN IS NOT SHOWN HERE, REFER TO *STANDARD HIGHWAY SIGN DESIGNS FOR TEXAS* AVAILABLE AT <https://www.txdot.gov/inside-txdot/forms-publications/publications/highway-signs.html> OR CONTACT TRANSPORTATION OPERATIONS STAFF AT 214-670-6904 FOR GUIDANCE.

CITY OF DALLAS DEPARTMENT OF TRANSPORTATION		
TRAFFIC SIGN LEGENDS AND IDENTIFICATION CODES		
APPROVED BY: GHASSAN KHANKARLI, P.E.	EFF DATE: June 2021	SHEET 7

ALL DIMENSIONS ARE IN INCHES
IF THE DIMENSION HAS A LETTER SUFFIX, IT INDICATES THE HIGHWAY FONT SERIES

DIMENSIONS- REGULATORY SIGNS

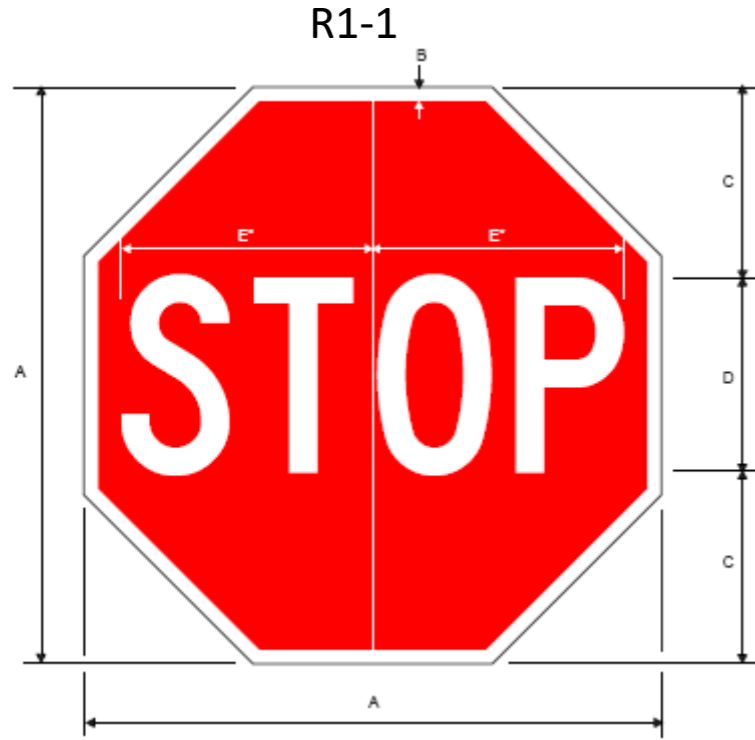

A	B	C	D	E
36	.875	12	12C	15

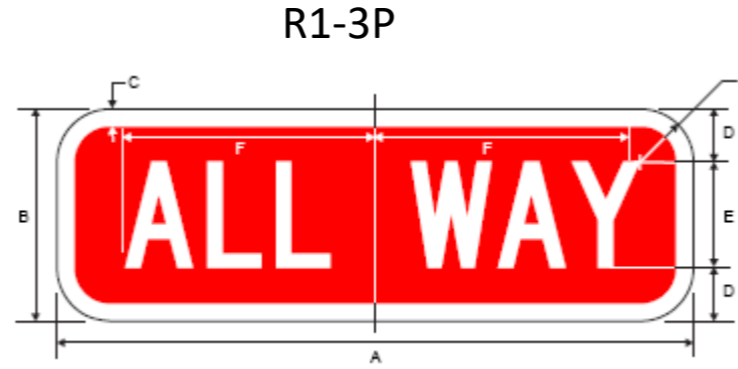

A	B	C	D	E	F	G
18	6	.5	1.5	3C	7	1.5

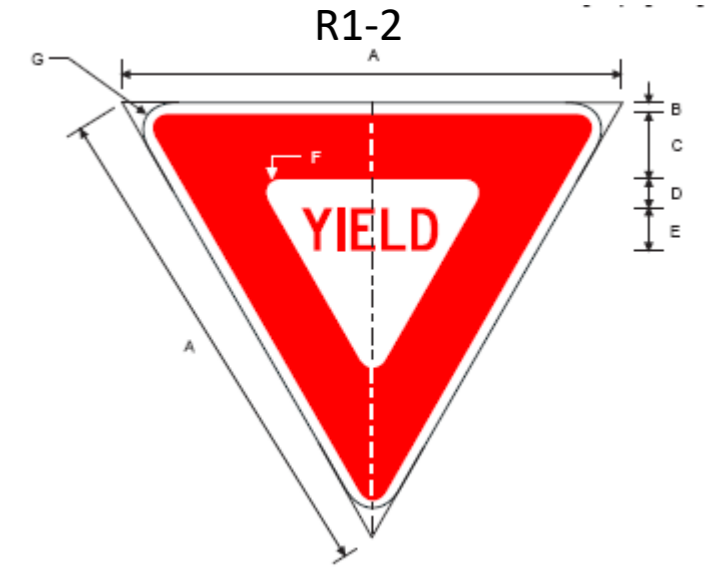

A	B	C	D	E	F	G
36	.75	5	2	3C	1.25	2

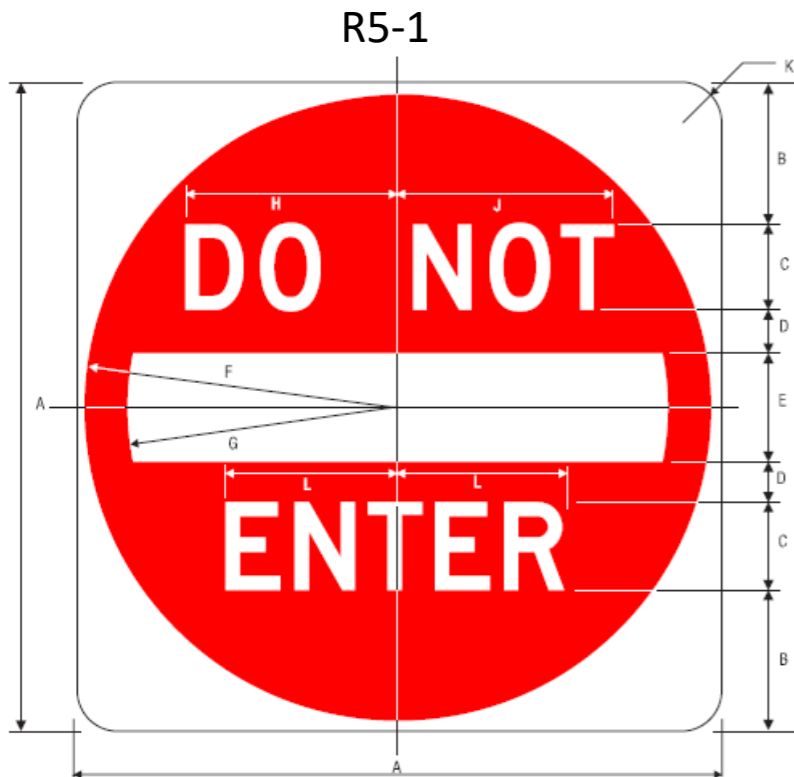

A	B	C	D	E	F	G	H	J	K	L
30	6.5	4D	2	5	14.5	12.5	9.75	10	1.875	7.875

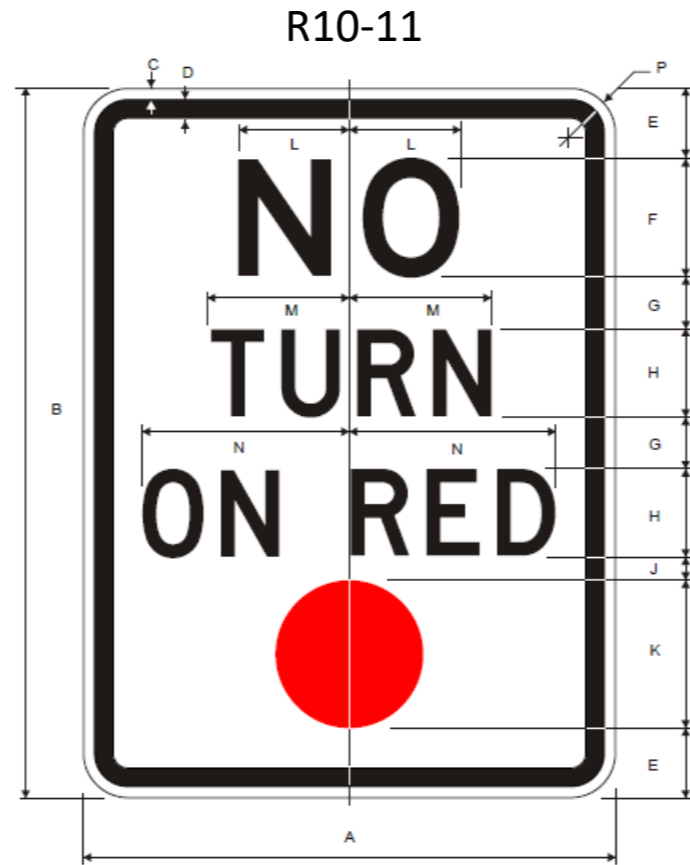

A	B	C	D	E	F	G	H	J	K	L	M	N	P
24	30	.375	.625	2.75	5E	2	4D	1.5	6	4.681	6.41	9.299	1.5

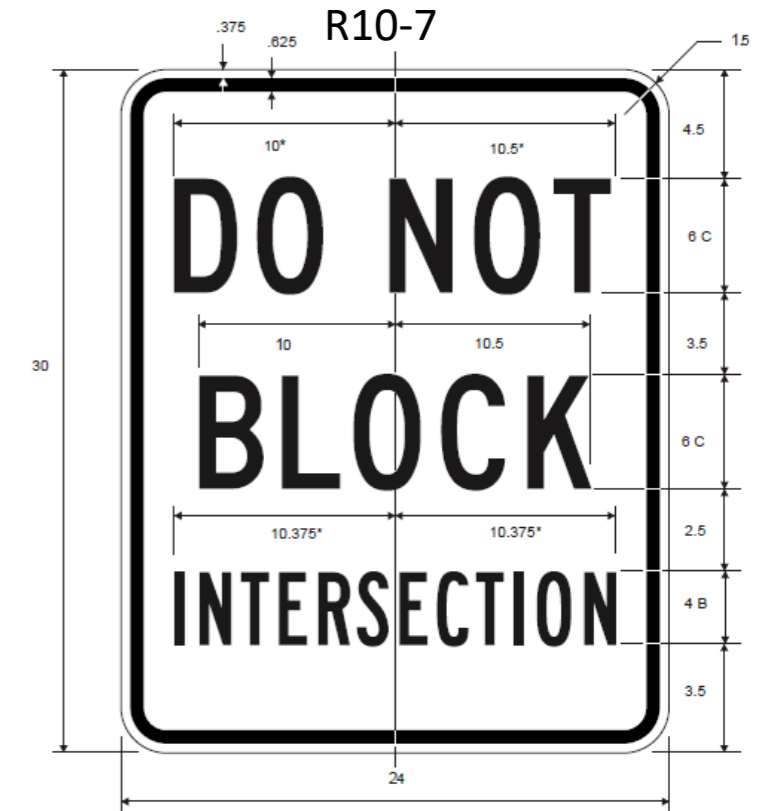

CITY OF DALLAS DEPARTMENT OF TRANSPORTATION		
TRAFFIC SIGN DIMENSIONS		
APPROVED BY: GHASSAN KHANKARLI, P.E.	EFF DATE: June 2021	SHEET 8

DIMENSIONS - REGULATORY SIGNS

R3-1

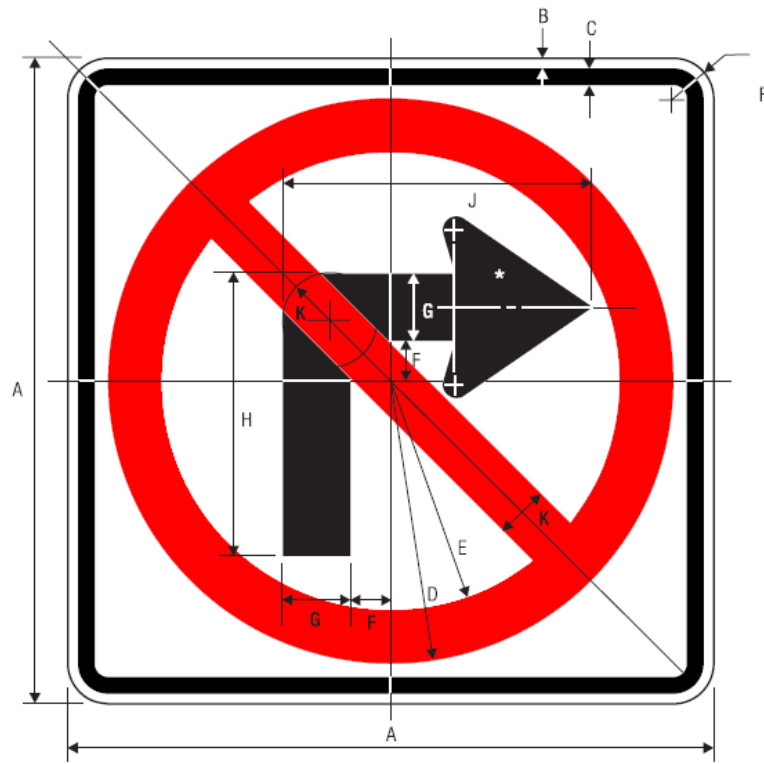

A	B	C	D	E	F	G	H	J	K
24	.375	.625	10.5	8.5	1.5	2.5	10.5	11.5	2

R3-2

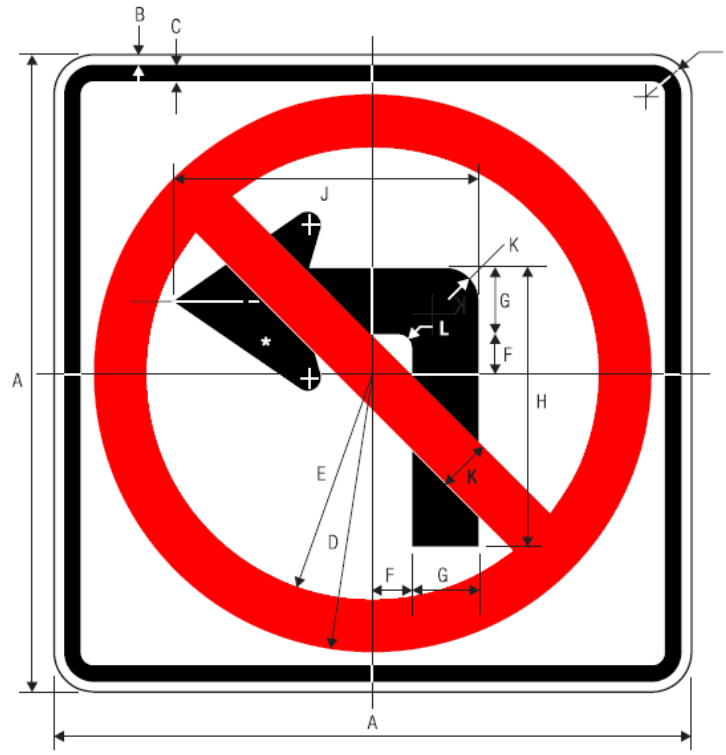

A	B	C	D	E	F	G	H	J	K	L
24	.375	.625	10.5	8.5	1.5	2.5	10.5	11.5	2	.5

R3-4



A	B	C	D	E	F	G	H	J	K	L	M
24	.375	.625	10.5	8.5	2.5	2.5	6	2.25	1.5	2	5

R9-3

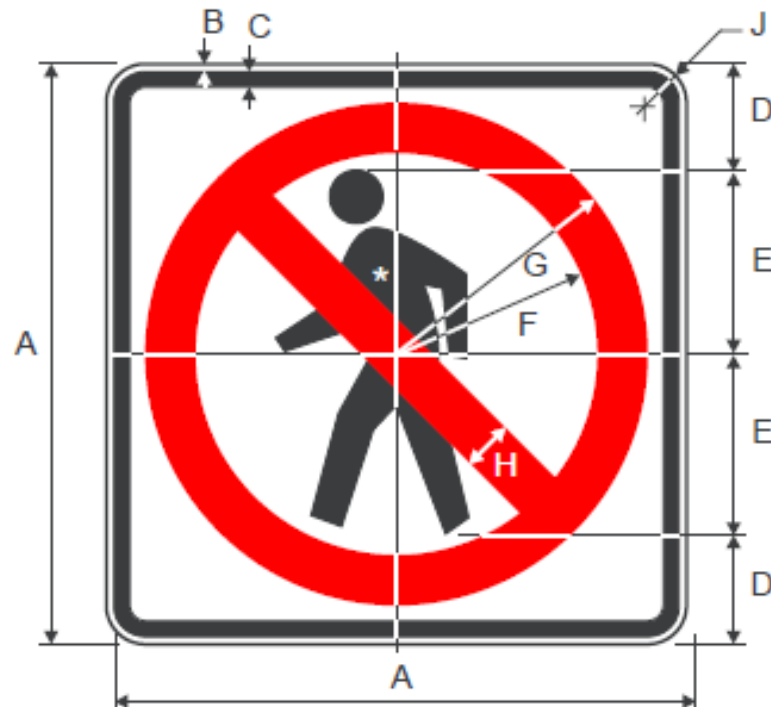

A	B	C	D	E	F	G	H	J
24	.375	.625	4.5	7.5	8.5	10.5	2	1.5

R5-2



A	B	C	D	E	F	G	H	J	K
24	.375	.625	10.5	8.5	6.875	6.875	1.375	1.5	1

ALL DIMENSIONS ARE IN INCHES
IF THE DIMENSION HAS A LETTER SUFFIX,
IT INDICATES THE HIGHWAY FONT SERIES

CITY OF DALLAS
DEPARTMENT OF TRANSPORTATION

TRAFFIC SIGN DIMENSIONS

APPROVED BY:
GHASSAN KHANKARLI, P.E.

EFF DATE:
June 2021

SHEET
9

DIMENSIONS - REGULATORY SIGNS

079

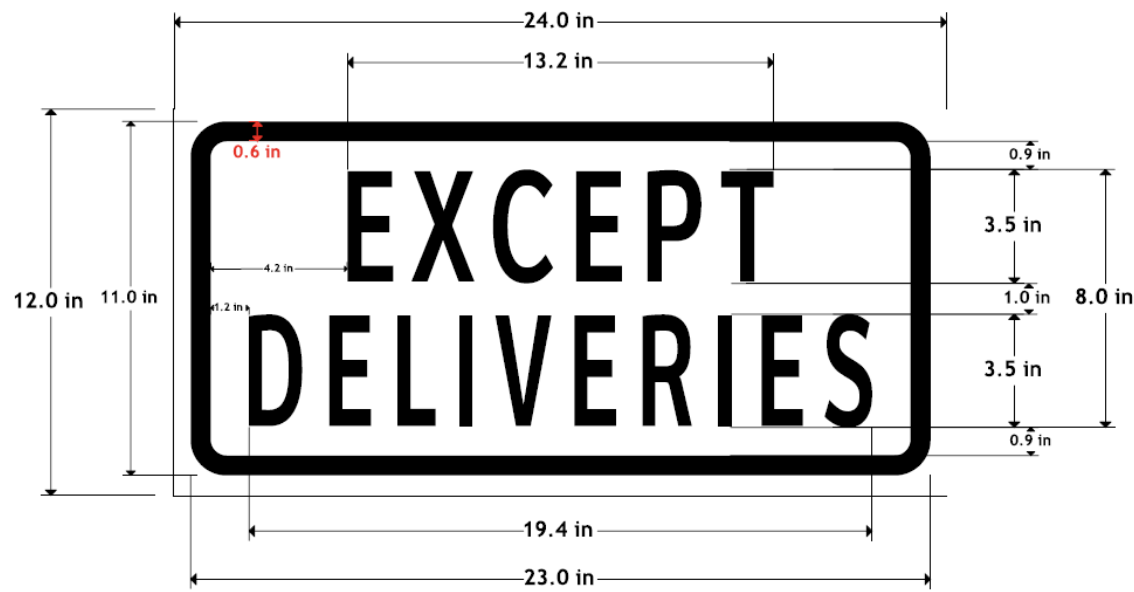

197

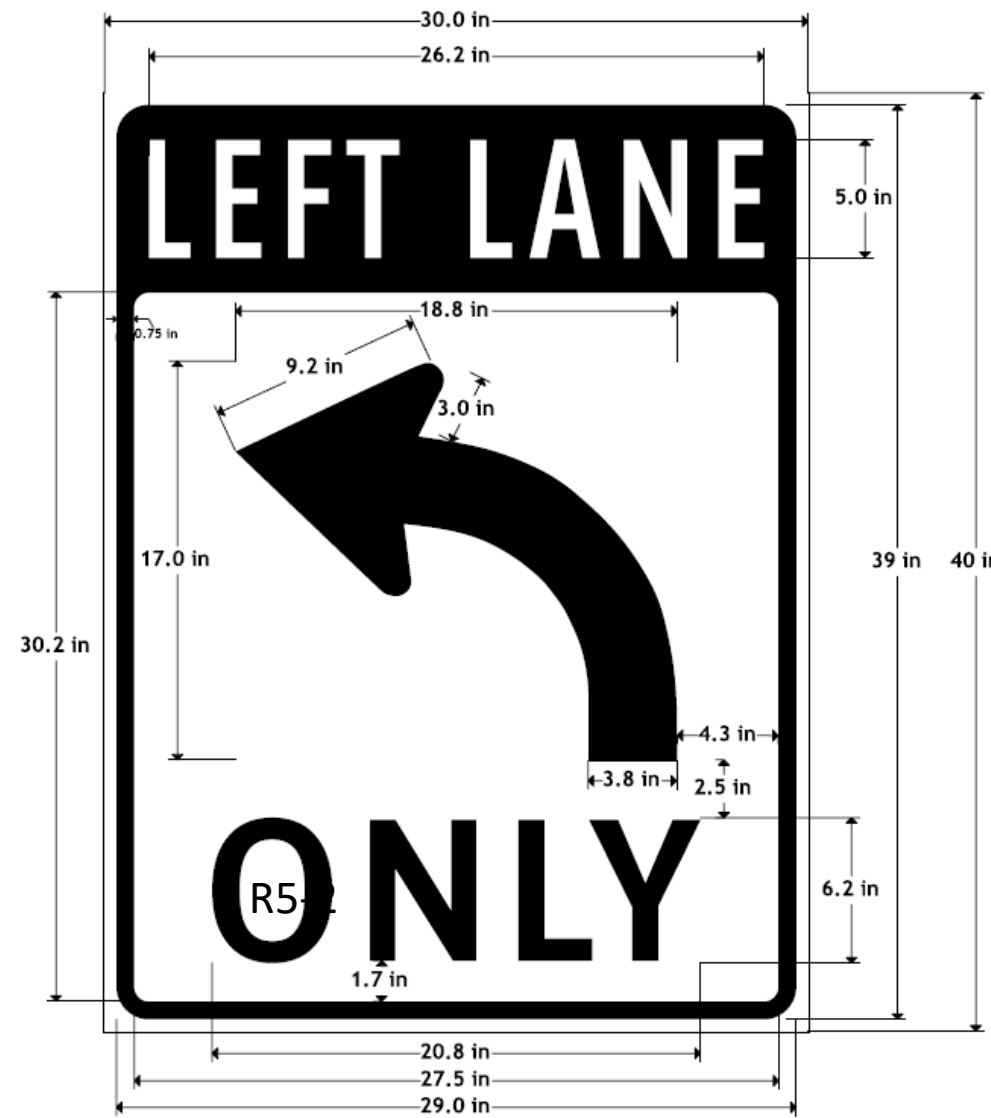

198

THE DIMENSIONS FOR SIGN 198 ARE SAME AS 197 UNLESS OTHERWISE NOTED



R3-5R

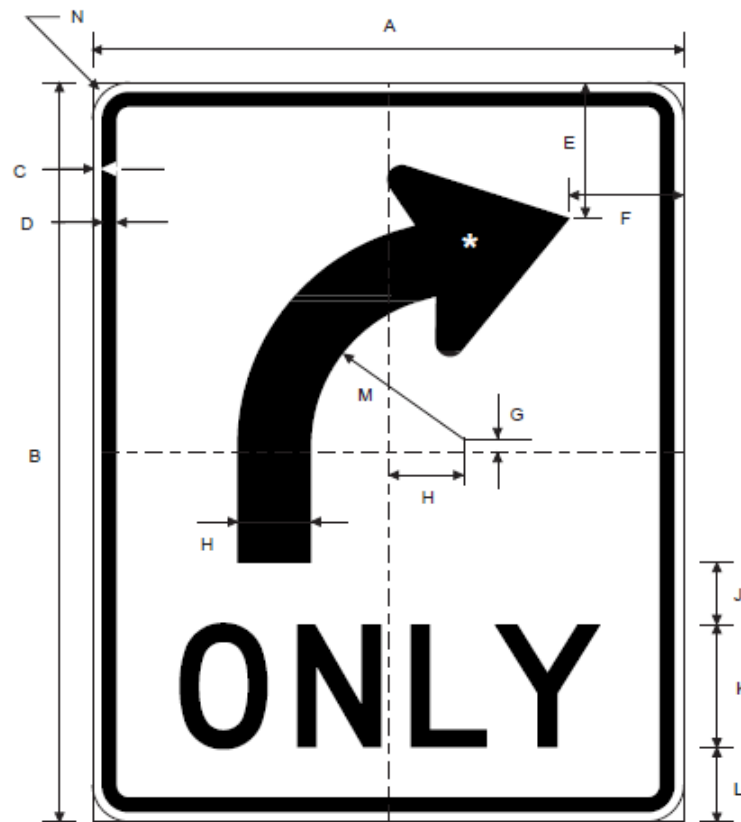

R3-5R

R3-5L (Same as R3-5R)



A	B	C	D	E	F	G	H	J	K	L	M	N
30	36	.5	.75	6.75	5.75	.5	3.75	2.5	6D	3.75	9.5	1.875

ALL DIMENSIONS ARE IN INCHES
IF THE DIMENSION HAS A LETTER SUFFIX, IT INDICATES THE HIGHWAY FONT SERIES

USE CLEARVIEW HIGHWAY 3W FONT FOR
079, 197 & 198 SIGNS

CITY OF DALLAS DEPARTMENT OF TRANSPORTATION		
TRAFFIC SIGN DIMENSIONS		
APPROVED BY: GHASSAN KHANKARLI, P.E.	EFF DATE: June 2021	SHEET 10

DIMENSIONS - REGULATORY SIGNS

R3-9b

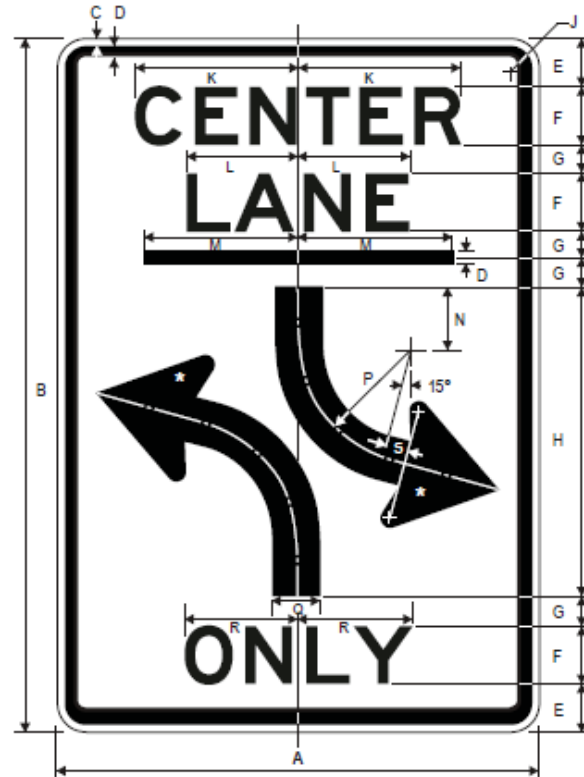

A	B	C	D	E	F	G	H	J	K	L	M
24	36	.375	.625	2.5	3 E	1.5	16	1.5	8.438	5.75	8

R3-8L

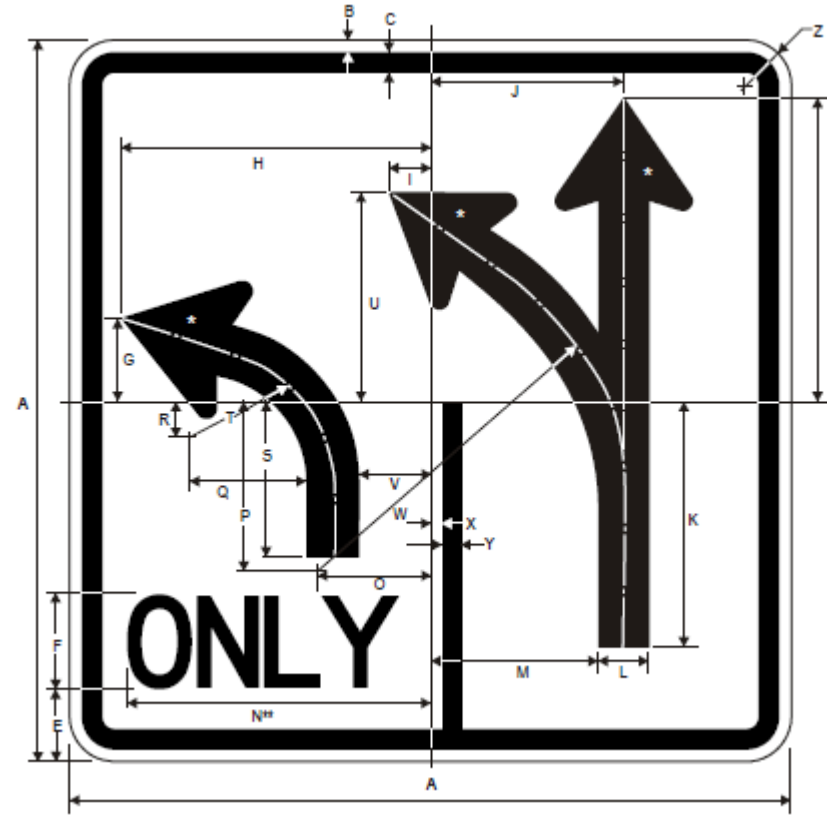

A	B	C	D	E	F	G	H	I	J	K	L	M
30	.5	.75	12.625	3	4 D	5	12.875	1.75	9.75	10.25	2.5	8.5

N	O	P	Q	R	S	T	U	V	W	X	Y	Z
12.332	4.75	7.5	4.5	2.625	6.5	5.75	8	2.75	14.5	.5	.75	1.875

M4-14

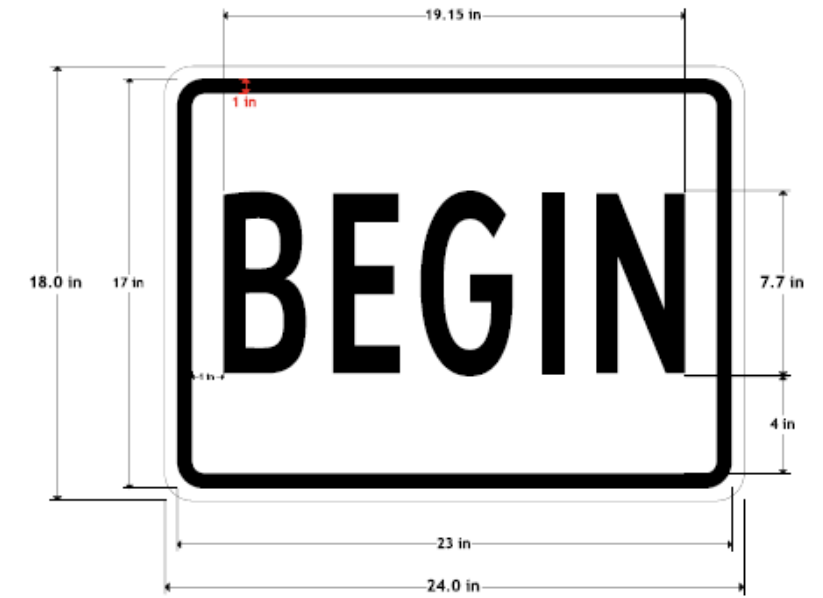

USE CLEARVIEW HIGHWAY 3W FONT FOR SIGN 084

R10-5L



A	B	C	D	E	F	G	H	J
24	30	.375	.625	3.25	4 C	2.5	4 D	1.5

R2-1 (SPEED LIMIT)



A	B	C	D	E	F	G	H	J	K	L
24	30	0.375	0.625	4	4 E	2	10 E	9.403	7.321	1.5

ALL DIMENSIONS ARE IN INCHES
IF THE DIMENSION HAS A LETTER SUFFIX, IT INDICATES THE HIGHWAY FONT SERIES

CITY OF DALLAS
DEPARTMENT OF TRANSPORTATION

TRAFFIC SIGN DIMENSIONS

APPROVED BY:
GHASSAN KHANKARLI, P.E.

EFF DATE:
June 2021

SHEET
11

DIMENSIONS - REGULATORY SIGNS

R6-2V

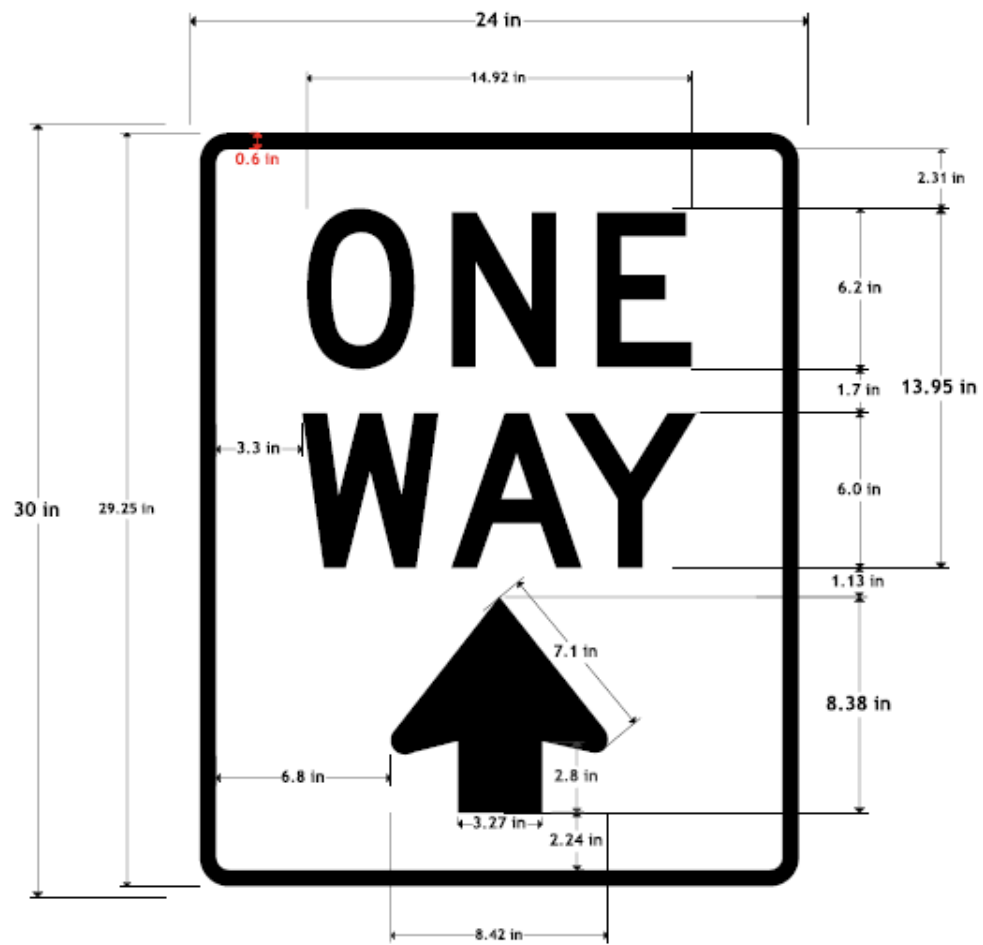

USE HIGHWAY FONT SERIES D FOR SIGN 127

R6-2R



R6-2L
(Same as R6-2R)



A	B	C	D	E	F	G	H	J	K	L	M	N	P	Q	R	S
24	30	0.375	0.625	3	6D	1.875	6.063	7.063	7.485	7.285	7.325	8.286	8.286	8.926	3	1.5

R9-3bPR

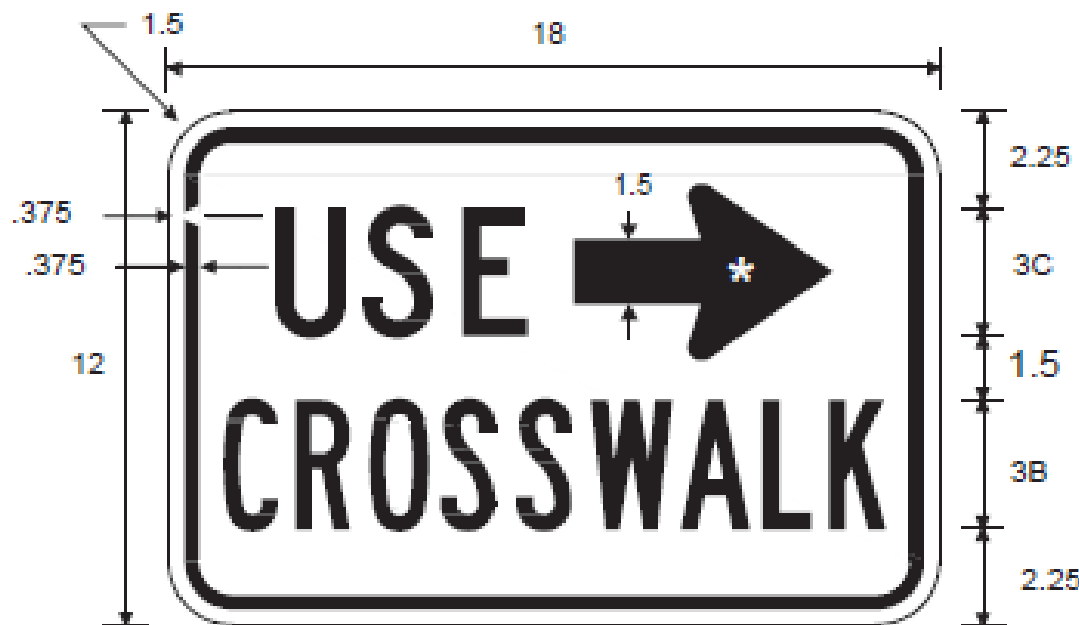

R9-3bPL
(Same as R9-3bPR)



ALL DIMENSIONS ARE IN INCHES
IF THE DIMENSION HAS A LETTER SUFFIX,
IT INDICATES THE HIGHWAY FONT SERIES

CITY OF DALLAS DEPARTMENT OF TRANSPORTATION		
TRAFFIC SIGN DIMENSIONS		
APPROVED BY: GHASSAN KHANKARLI, P.E.	EFF DATE: June 2021	SHEET 12

DIMENSIONS - REGULATORY SIGNS

R4-7

R10-6aL

ARROW DETAIL

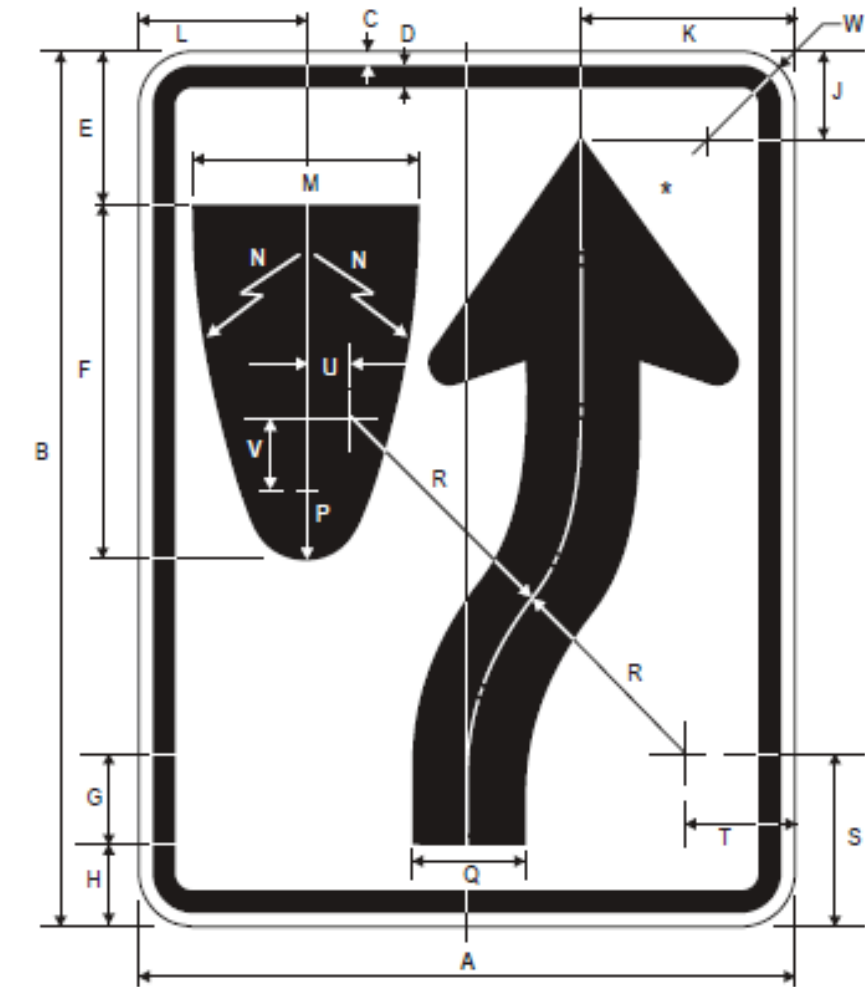
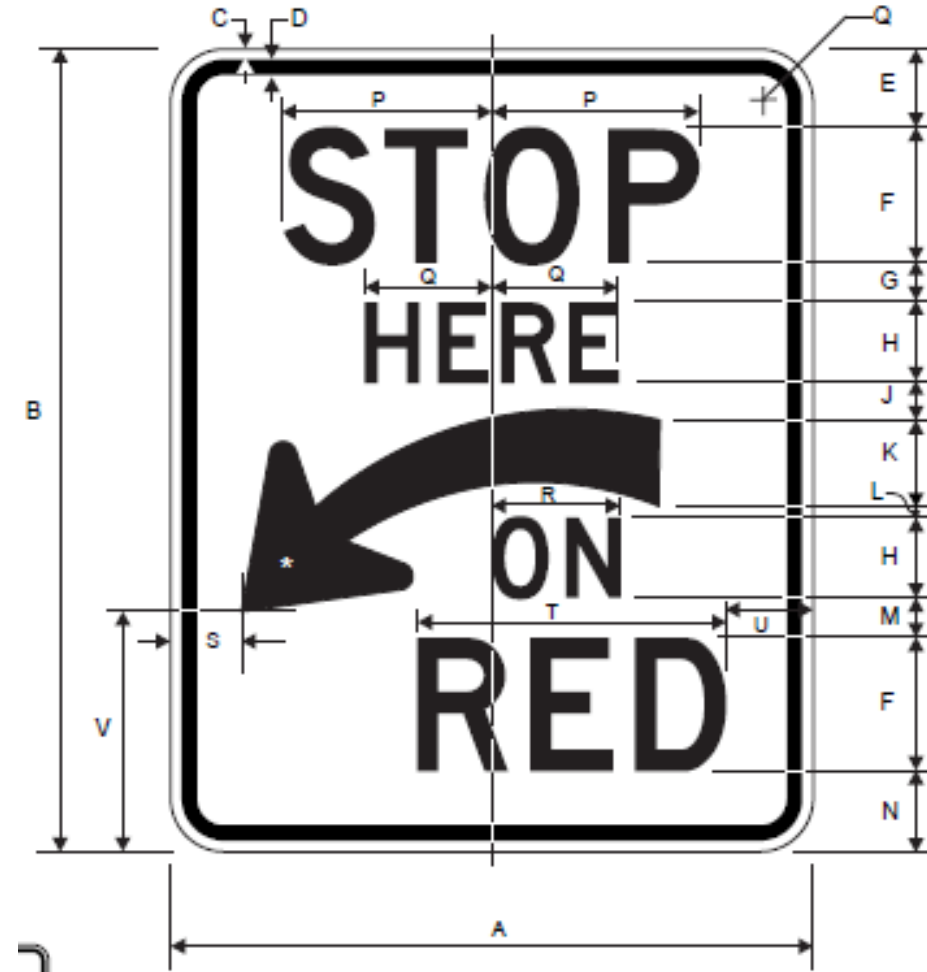
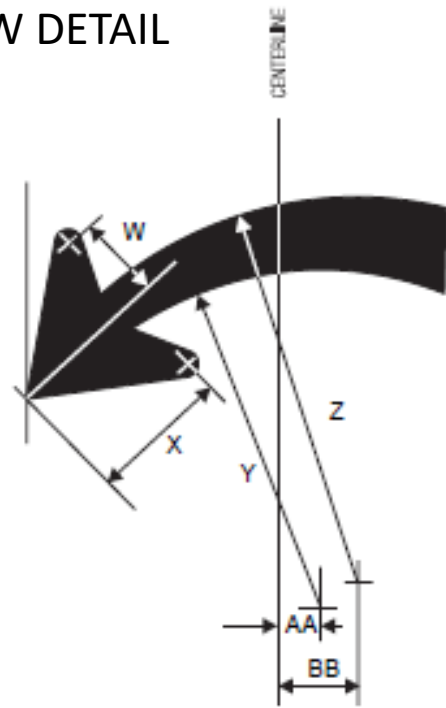

A	B	C	D	E	F	G	H	J	K	L	M
18	24	.375	.625	3.375	9.375	1.875	2.25	1.375	5.5	4.688	6

N	P	Q	R	S	T	U	V	W
22.5	1.5	3	6.75	4.125	2.25	1.063	.438	1.5

A	B	C	D	E	F	G	H	J	K
24	30	0.375	0.625	3	5D	1.5	3D	1.25	3.25

R10-6aR
(Same as R10-6aL)

L	M	N	P	Q	R	S	T	U	V
0.5	1.5	3	8.188	4.875	4.875	2.625	11.88	3.25	8.5

W	X	Y	Z	AA	BB	CC
3.188	5.375	14.44	13.13	2.5	4	1.5



ALL DIMENSIONS ARE IN INCHES
IF THE DIMENSION HAS A LETTER SUFFIX,
IT INDICATES THE HIGHWAY FONT SERIES

CITY OF DALLAS DEPARTMENT OF TRANSPORTATION		
TRAFFIC SIGN DIMENSIONS		
APPROVED BY: GHASSAN KHANKARLI, P.E.	EFF DATE: June 2021	SHEET 13

DIMENSIONS - REGULATORY SIGNS

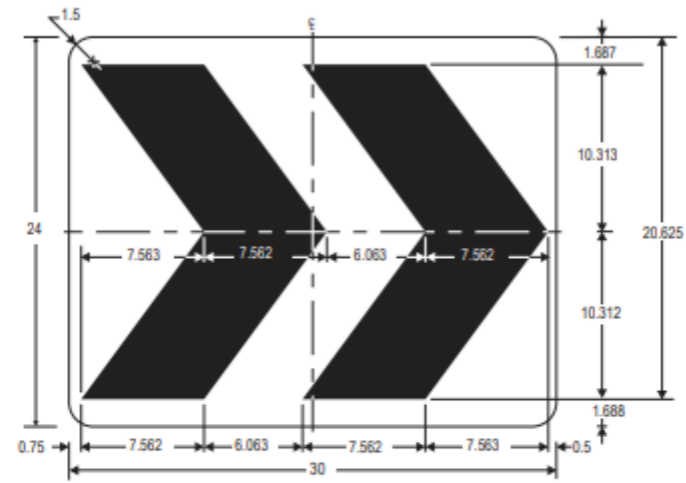

R6-4

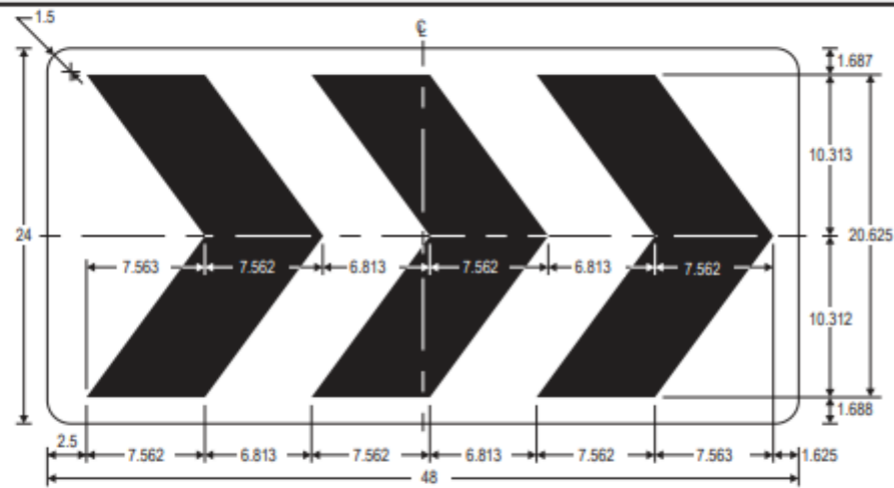

R6-4a

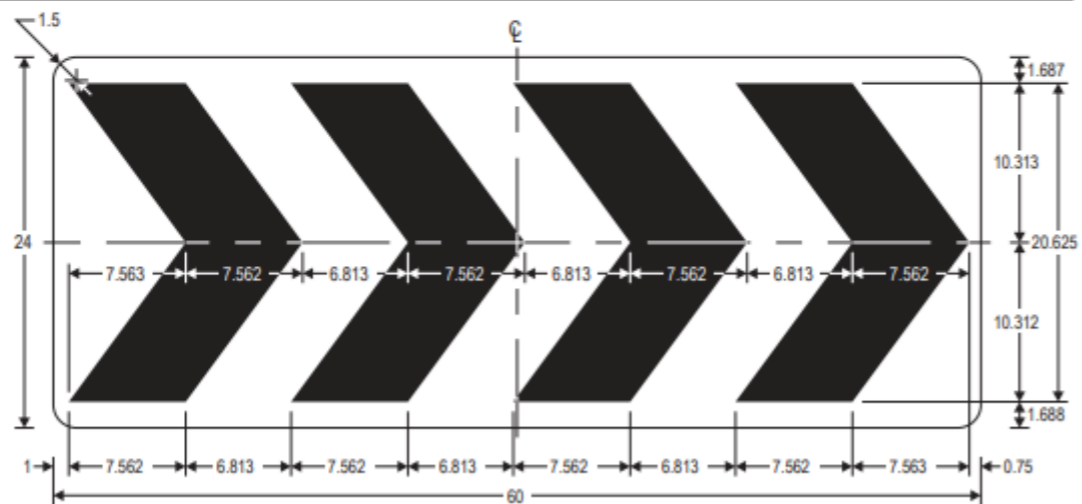

R6-4b

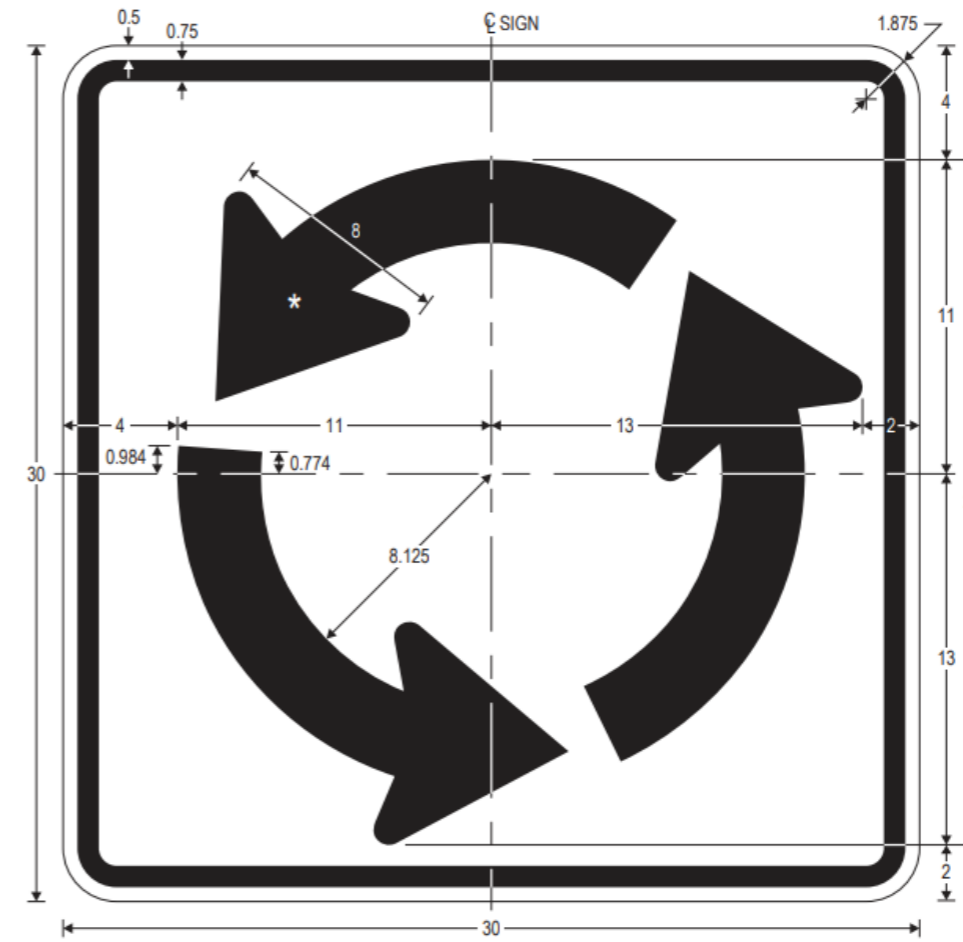

R6-5P

ALL DIMENSIONS ARE IN INCHES
IF THE DIMENSION HAS A LETTER SUFFIX,
IT INDICATES THE HIGHWAY FONT SERIES

CITY OF DALLAS DEPARTMENT OF TRANSPORTATION		
TRAFFIC SIGN DIMENSIONS		
APPROVED BY: GHASSAN KHANKARLI, P.E.	EFF DATE: June 2021	SHEET 14

DIMENSIONS - REGULATORY SIGNS

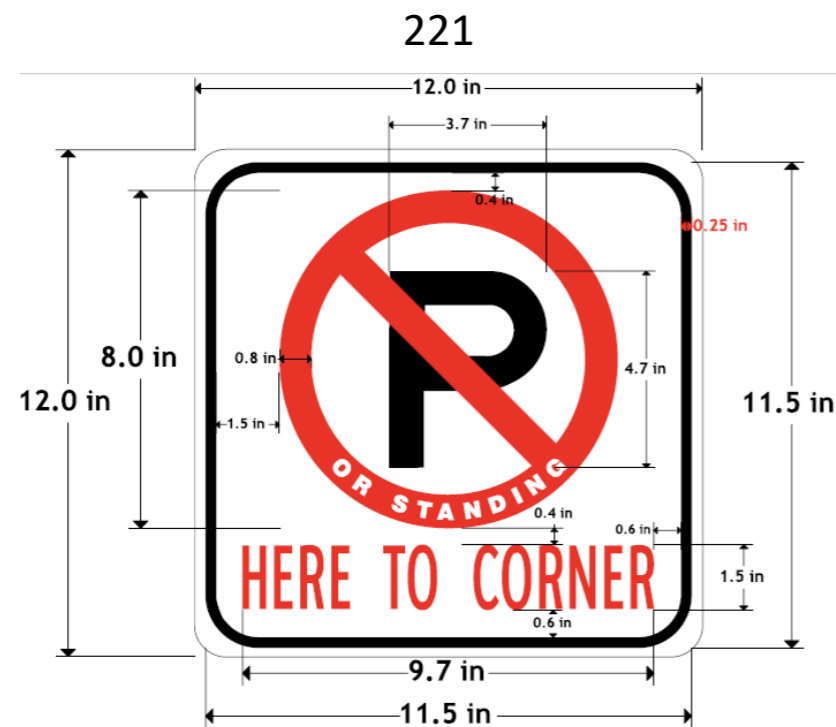
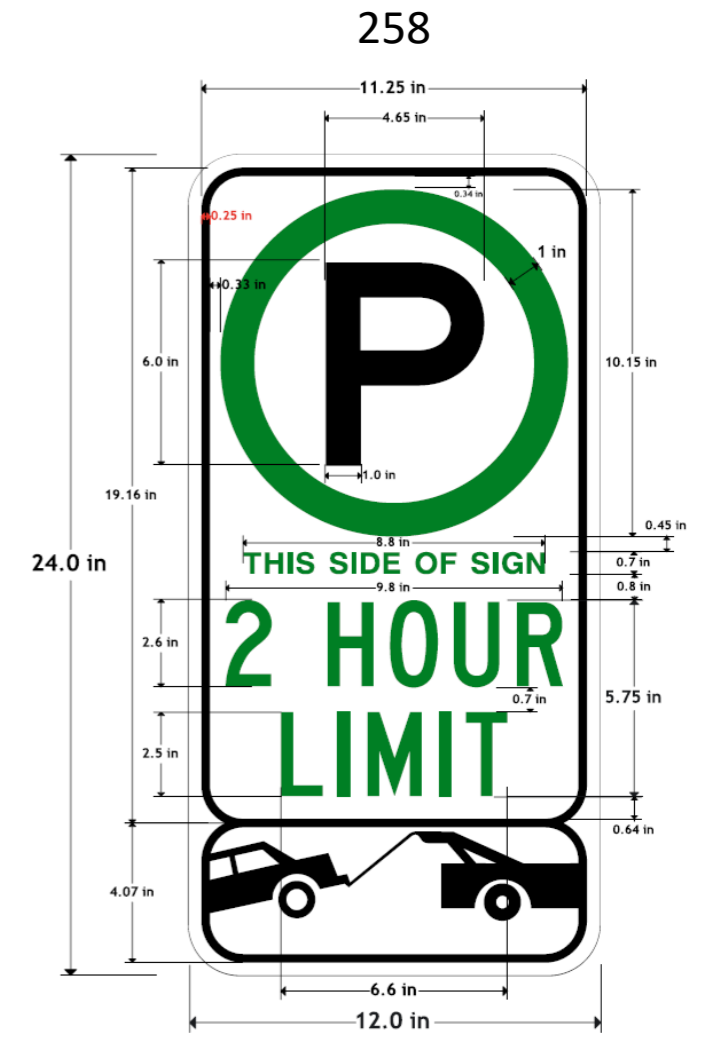
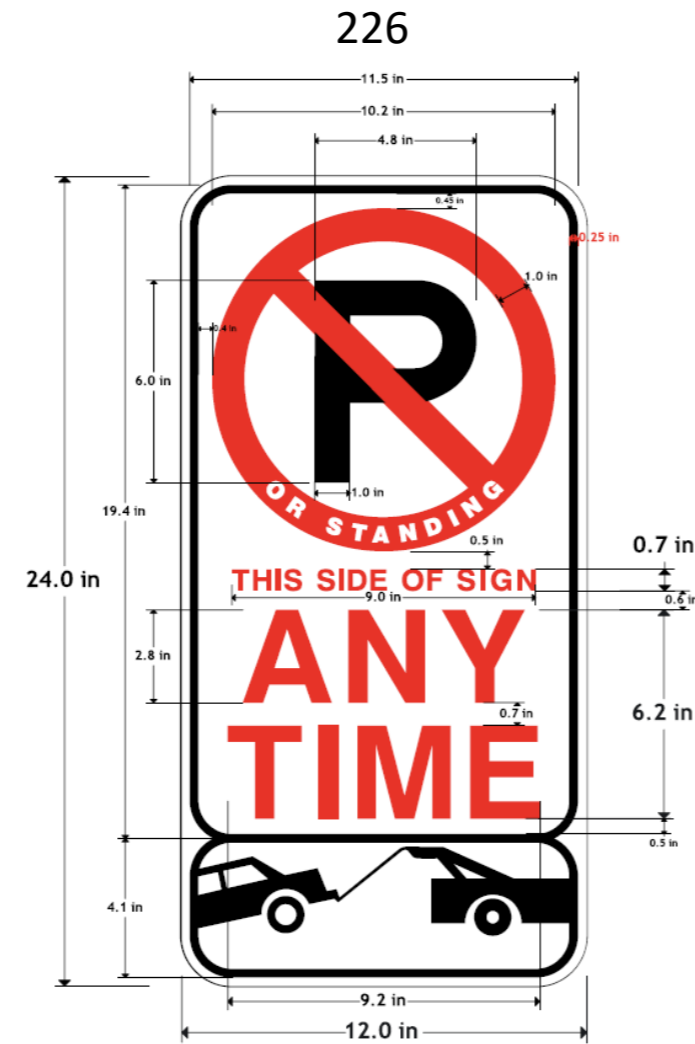

FOR SIGNS 221, 225, 226, 229 & 258, USE HIGHWAY FONT SERIES E (MODIFIED) FOR THE "P", & HIGHWAY FONT SERIES C FOR ALL OTHER TEXT

ALL DIMENSIONS ARE IN INCHES
IF THE DIMENSION HAS A LETTER SUFFIX,
IT INDICATES THE HIGHWAY FONT SERIES

CITY OF DALLAS DEPARTMENT OF TRANSPORTATION		
TRAFFIC SIGN DIMENSIONS		
APPROVED BY: GHASSAN KHANKARLI, P.E.	EFF DATE: June 2021	SHEET 15

DIMENSIONS - SCHOOL SIGNS

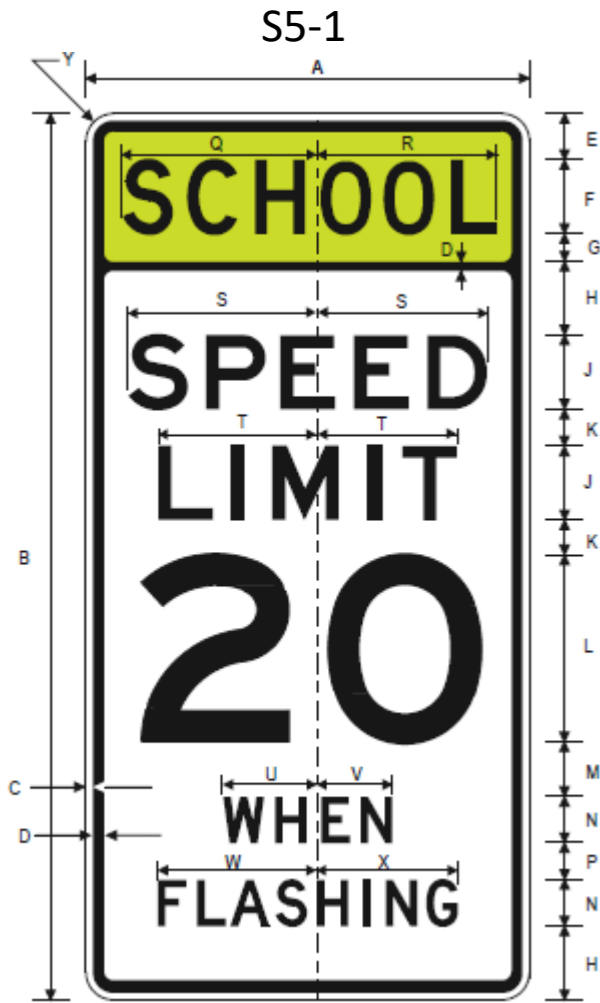

A	B	C	D	E	F	G	H	J	K	L	M
24	48	.375	.625	2.5	4D	1.5	4	4E	2	10E	3
N	P	Q	R	S	T	U	V	W	X	Y	
2.5D	2	10	10.25	9.563	7.438	5.188	5.125	9.188	9.625	1.5	

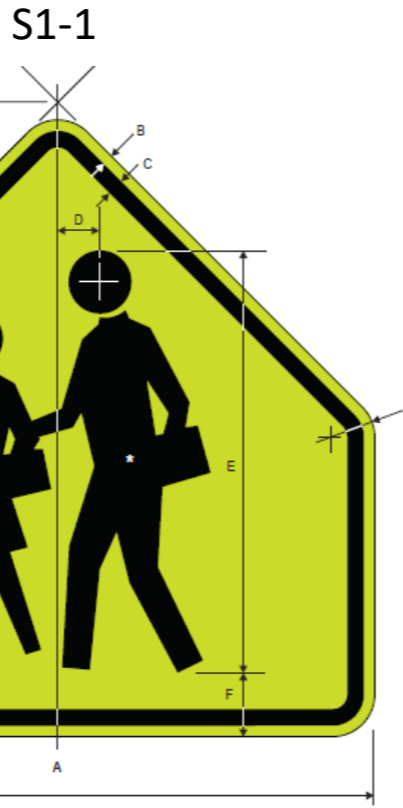

A	B	C	D	E	F	G	H
30	.5	.75	2	20	3	3.75	1.875
36	.625	.875	2.5	24	3.5	4.5	2.25

FOR SIGN 081, USE HIGHWAY FONT SERIES D
 FOR SIGN 099, USE CLEARVIEW 1B
 FOR SIGN 086, USE CLEARVIEW 4B

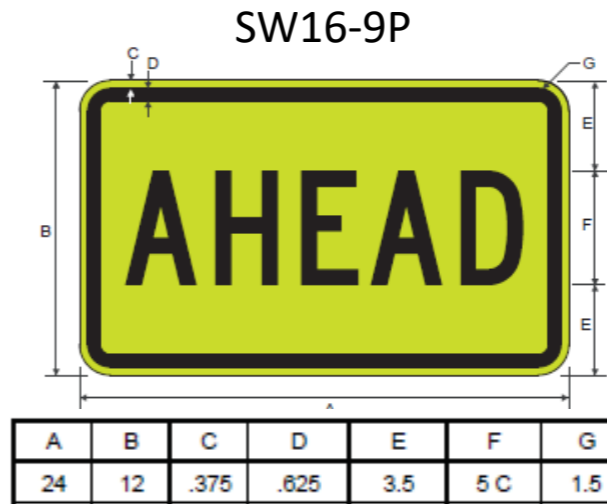

A	B	C	D	E	F	G
24	12	.375	.625	3.5	5C	1.5

ALL DIMENSIONS ARE IN INCHES
 IF THE DIMENSION HAS A LETTER SUFFIX,
 IT INDICATES THE HIGHWAY FONT SERIES

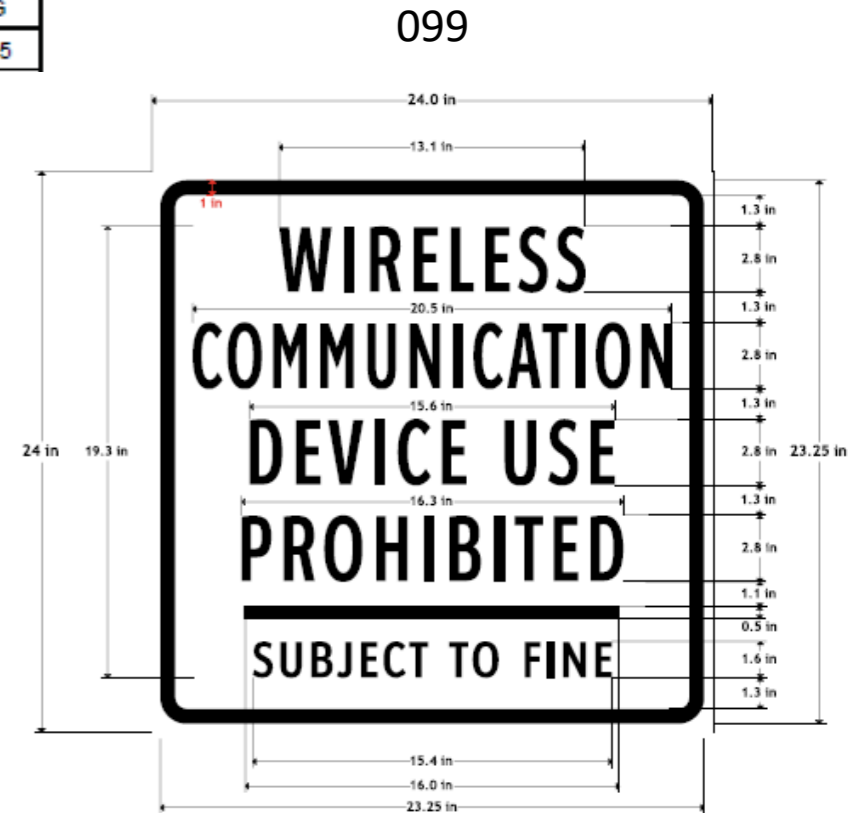

SW16-7PL(R)

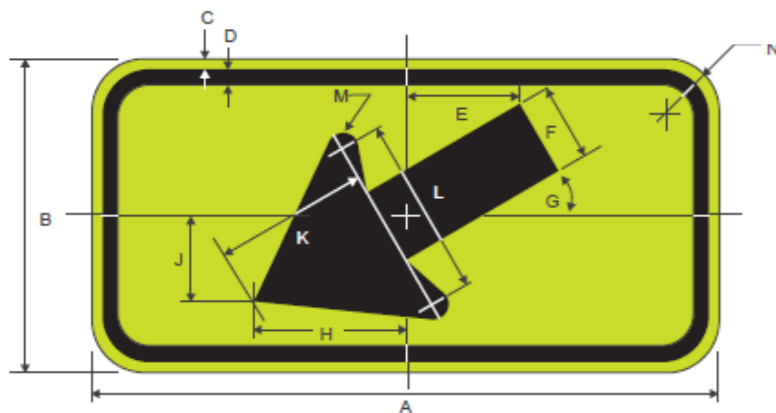

A	B	C	D	E	F	G	H	J	K	L	M	N
24	12	.375	.625	4.323	3	30°	5.844	3.282	5.884	6.925	.6	1.5
30	18	.5	.75	6.524	4.5	30°	8.766	4.923	8.846	10.407	.92	1.875

S5-2aTP

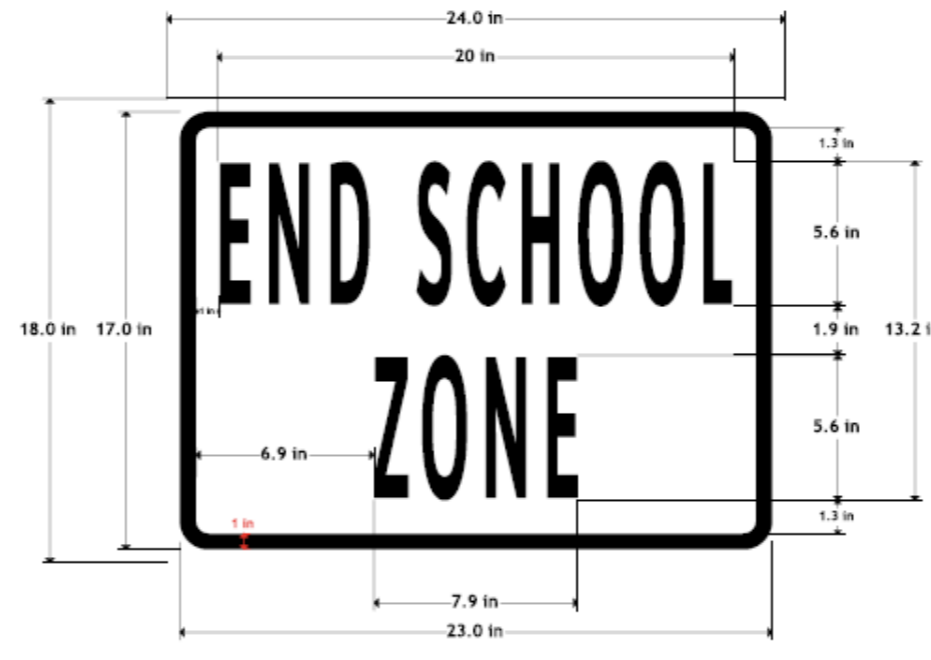

CITY OF DALLAS DEPARTMENT OF TRANSPORTATION		
TRAFFIC SIGN DIMENSIONS		
APPROVED BY: GHASSAN KHANKARLI, P.E.	EFF DATE: June 2021	SHEET 16

DIMENSIONS - WARNING SIGNS

W3-3

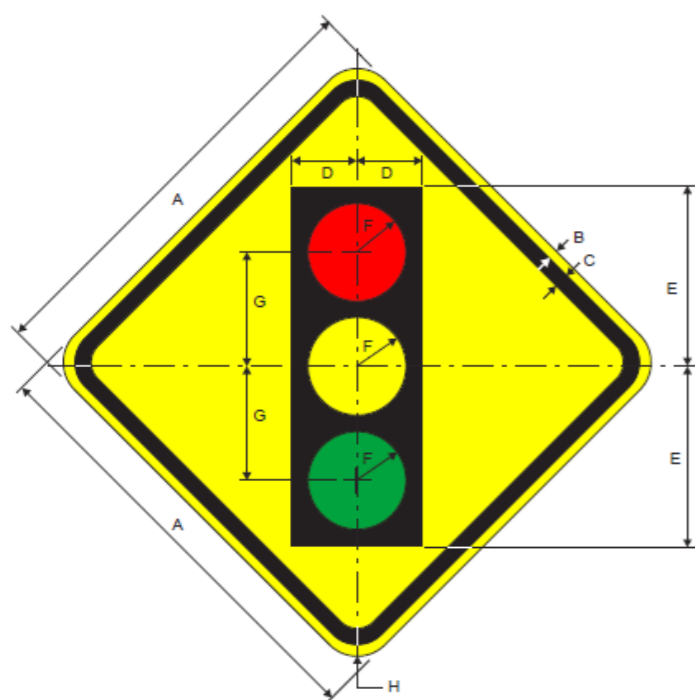

A	B	C	D	E	F	G	H
30	.5	.75	5	13.75	3.75	8.75	1.875

W3-1

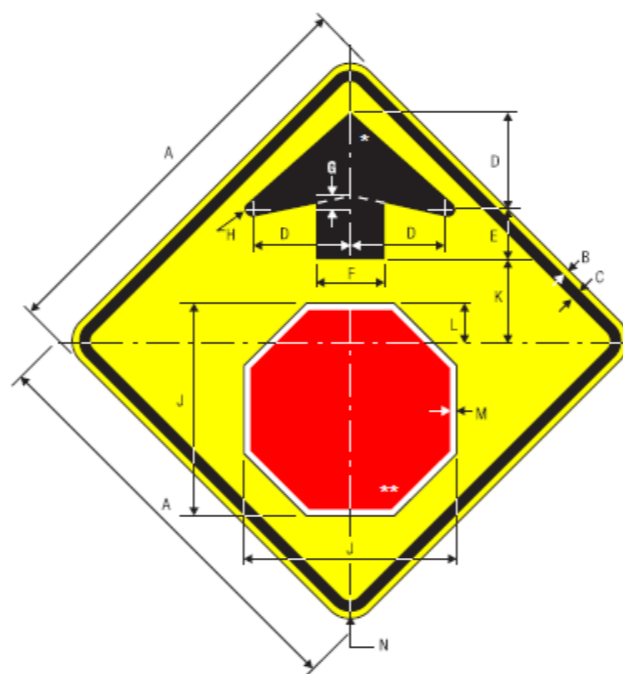

A	B	C	D	E	F	G	H	J	K	L	M	N
30	.5	.75	7.5	3.75	5	.625	.313	15.75	6.25	2.875	.5	1.875

W4-2R

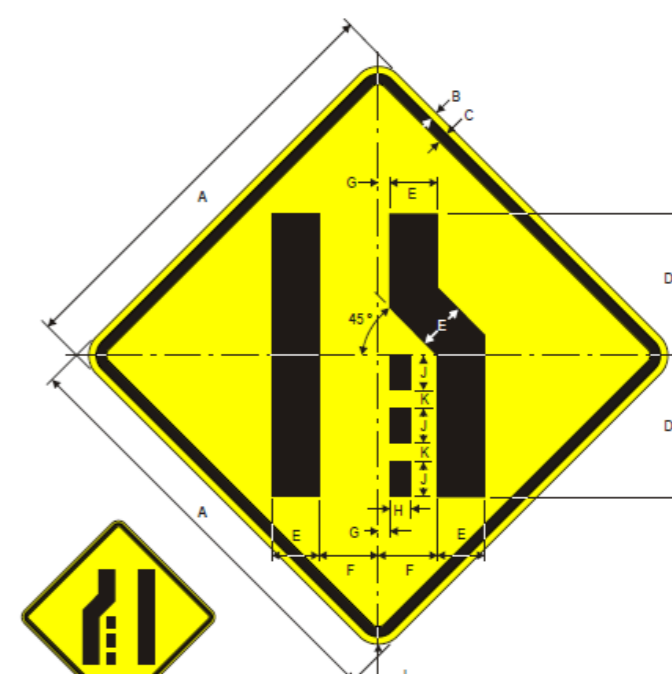

A	B	C	D	E	F	G	H	J	K	L
30	.5	.75	10	3.375	4.188	.875	1.5	2.5	1.25	1.875

W6-3

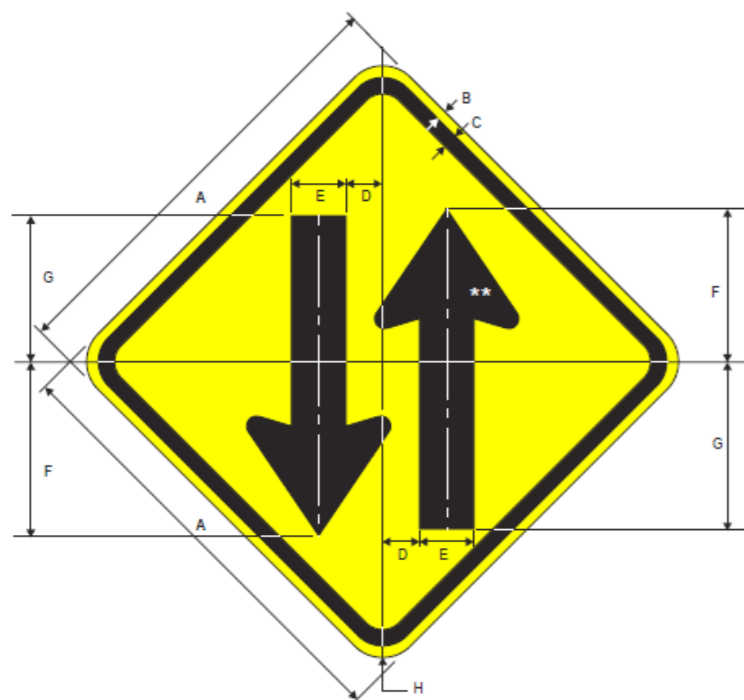

A	B	C	D	E	F	G	H
30*	.5	.75	2.438	3.75	11.25	10.625	1.875

W1-1R

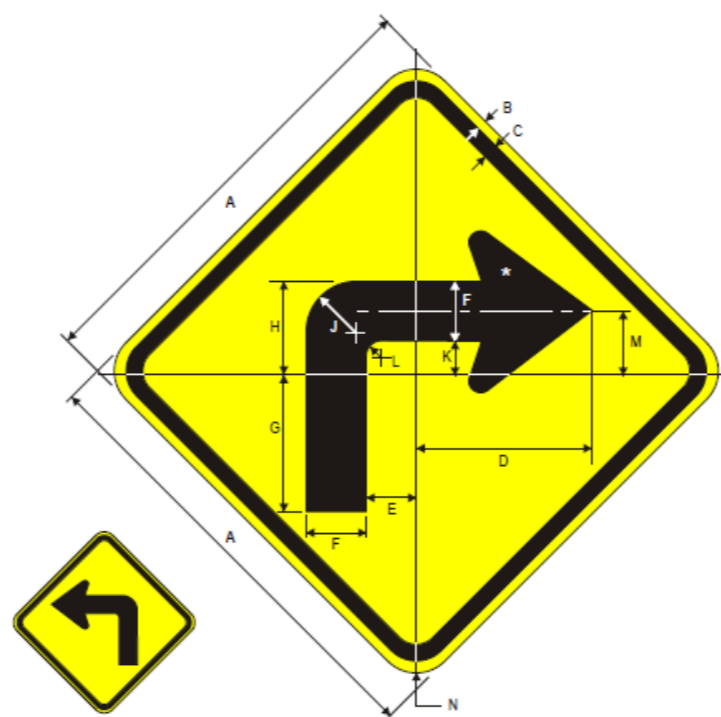

A	B	C	D	E	F	G	H	J	K	L	M	N
30	.5	.75	12	3.75	4.375	9.688	6.25	3	1.875	1	4.063	1.875

ALL DIMENSIONS ARE IN INCHES
IF THE DIMENSION HAS A LETTER SUFFIX, IT INDICATES THE HIGHWAY FONT SERIES

CITY OF DALLAS
DEPARTMENT OF TRANSPORTATION

TRAFFIC SIGN DIMENSIONS

APPROVED BY:
GHASSAN KHANKARLI, P.E.

EFF DATE:
June 2021

SHEET
17

DIMENSIONS - WARNING SIGNS

W1-2R

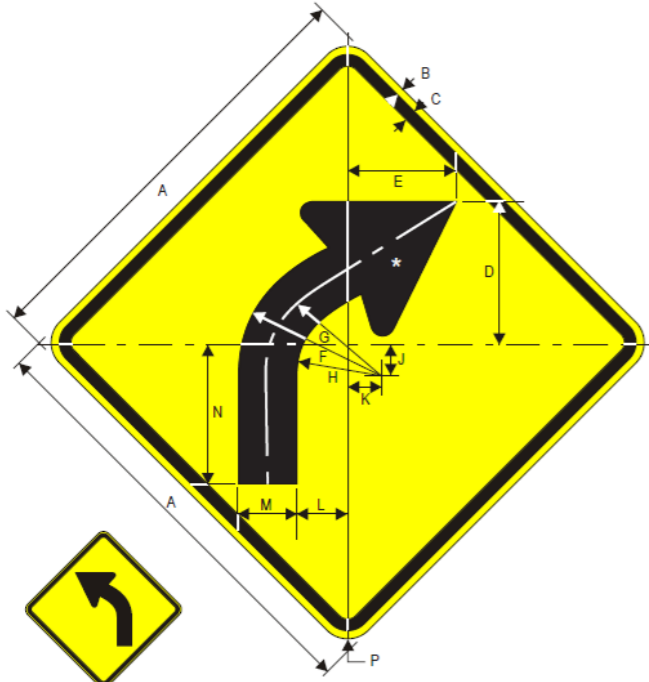

W1-2L

W2-2R

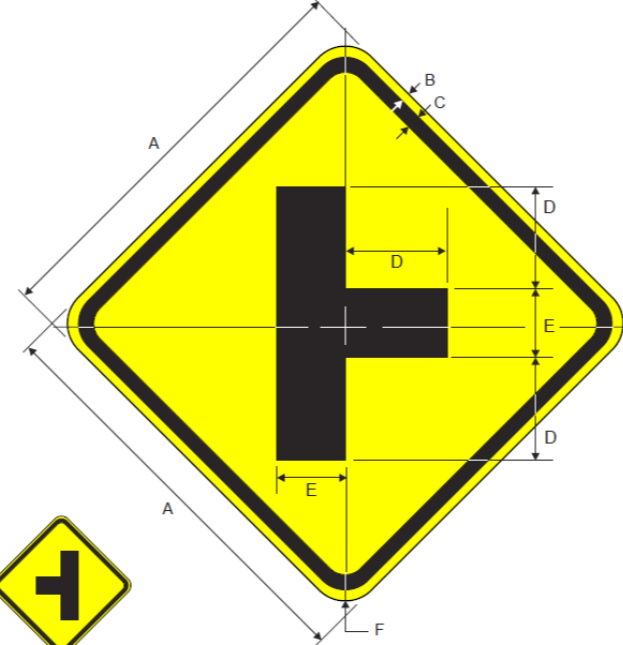

W2-2L

W2-1

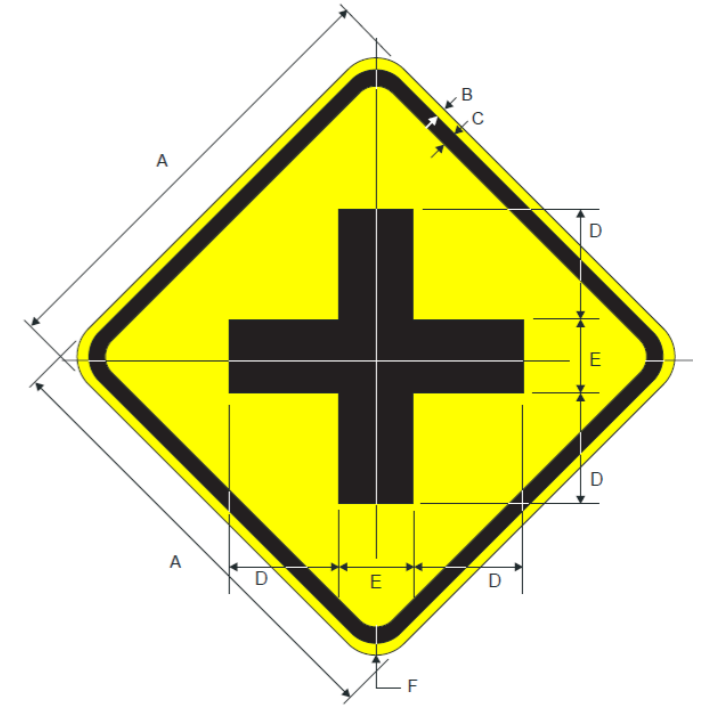

A	B	C	D	E	F	G	H	J	K	L	M	N	P
30	.5	.75	8.875	9.063	10	7.813	5.625	2.938	2.188	3.438	4.375	10.313	1.875

A	B	C	D	E	F
30	.5	.75	10	5	1.875

A	B	C	D	E	F
30	.5	.75	10	5	1.875

W10-1

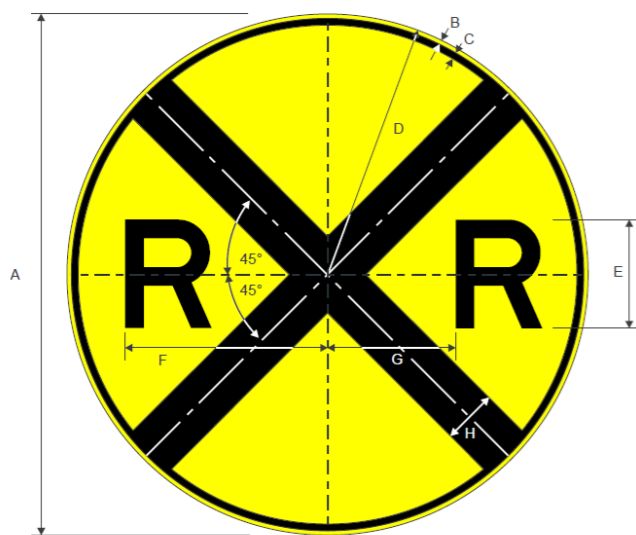

A	B	C	D	E	F	G	H
30	.5	.75	15	7E	12.375	7.125	3

154

FOR SIGN 154, USE CLEARVIEW 3B



ALL DIMENSIONS ARE IN INCHES
IF THE DIMENSION HAS A LETTER SUFFIX, IT INDICATES THE HIGHWAY FONT SERIES

W16-9P



A	B	C	D	E	F	G
24	12	.375	.625	3.5	5C	1.5

CITY OF DALLAS DEPARTMENT OF TRANSPORTATION		
TRAFFIC SIGN DIMENSIONS		
APPROVED BY: GHASSAN KHANKARLI, P.E.	EFF DATE: June 2021	SHEET 18

DIMENSIONS - WARNING SIGNS

W1-8

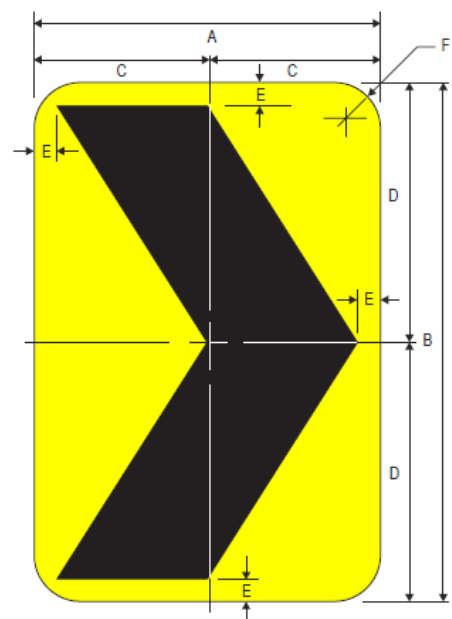

W1-8L

W1-8R

A	B	C	D	E	F
18	24	9	12	.75	1.5

W6-1

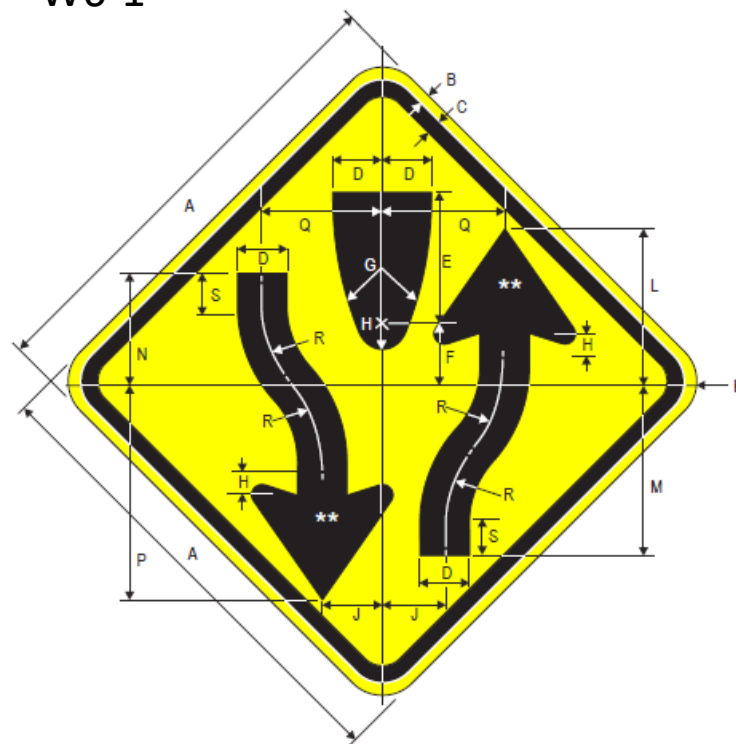

A	B	C	D	E	F	G	H	J	K	L	M	N	P	Q	R	S
30*	.5	.75	3.313	8.313	4.125	25	1.688	4.125	1.875	10	11.625	7.938	13.688	7.875	8.313	2.063

072

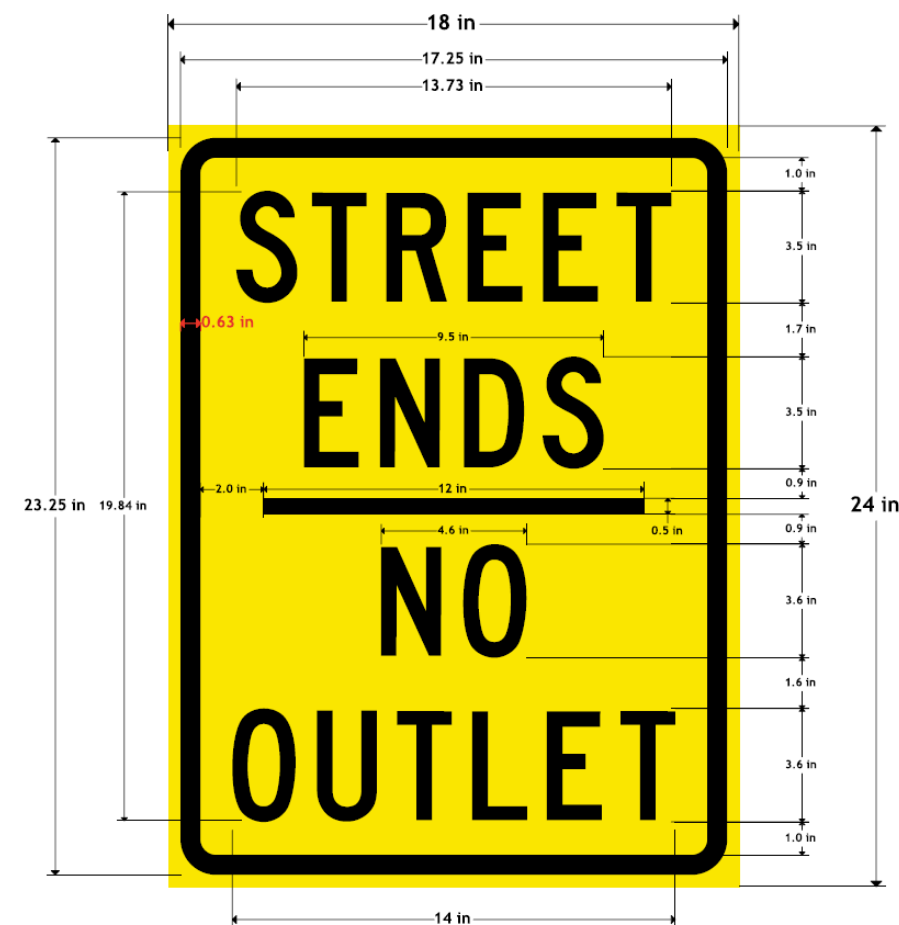

FOR SIGN 072, USE HIGHWAY FONT SERIES D

W13

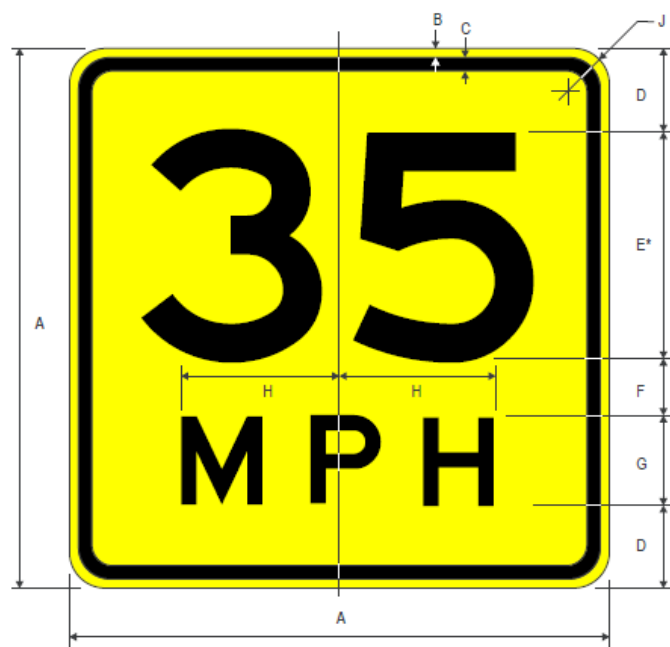

* Optically space numerals about centerline

A	B	C	D	E	F	G	H	J
24	.375	.625	3.625	10 E	2.75	4 E	6.284	1.5

W4-4P



* ALTERNATE TEXT WITH APPROVAL BY TRAFFIC OPERATIONS

A	B	C	D	E	F	G	H	J	K	L	M	N	P
24	12	.375	0.625	2.875	2.25 C	1.75	9.314	9.875	1.5	10.054	10.176	9.889	2.25 B

ALL DIMENSIONS ARE IN INCHES
IF THE DIMENSION HAS A LETTER SUFFIX,
IT INDICATES THE HIGHWAY FONT SERIES

CITY OF DALLAS DEPARTMENT OF TRANSPORTATION		
TRAFFIC SIGN DIMENSIONS		
APPROVED BY: GHASSAN KHANKARLI, P.E.	EFF DATE: June 2021	SHEET 19

DIMENSIONS - WARNING SIGNS

W1-6

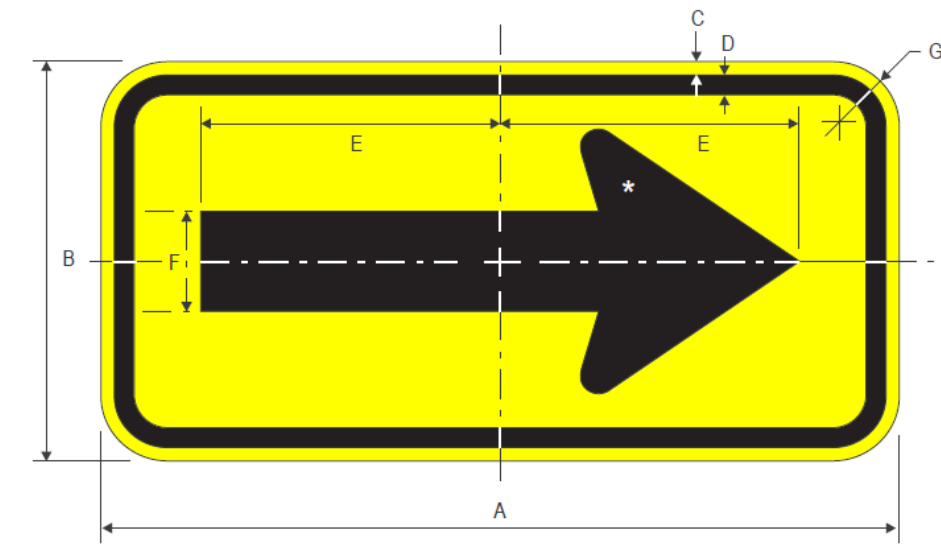

W1-6R



W1-6L

A	B	C	D	E	F	G
48	24	.5	.75	19.5	6.5	1.875

W1-7

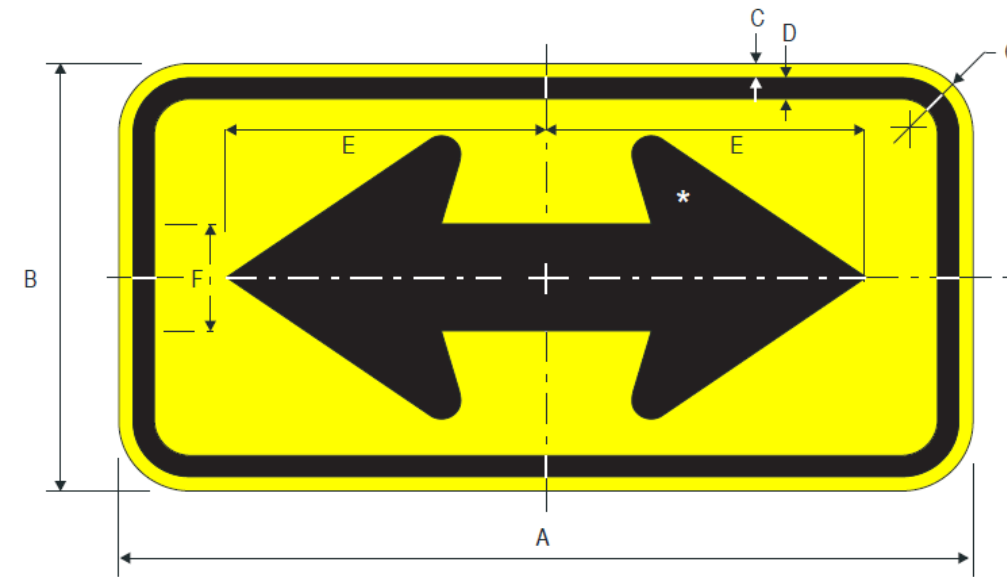

A	B	C	D	E	F	G
48	24	.5	.75	20.5	6.5	1.875

W11-2

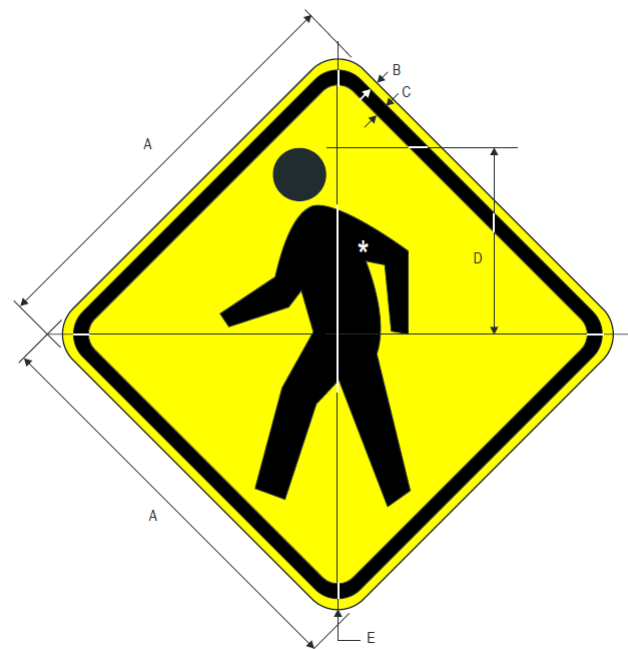

A	B	C	D	E
30	.5	.75	13.5	1.875

ALL DIMENSIONS ARE IN INCHES
IF THE DIMENSION HAS A LETTER SUFFIX,
IT INDICATES THE HIGHWAY FONT SERIES

CITY OF DALLAS DEPARTMENT OF TRANSPORTATION		
TRAFFIC SIGN DIMENSIONS		
APPROVED BY: GHASSAN KHANKARLI, P.E.	EFF DATE: June 2021	SHEET 20

DIMENSIONS - WARNING SIGNS

W16-15P

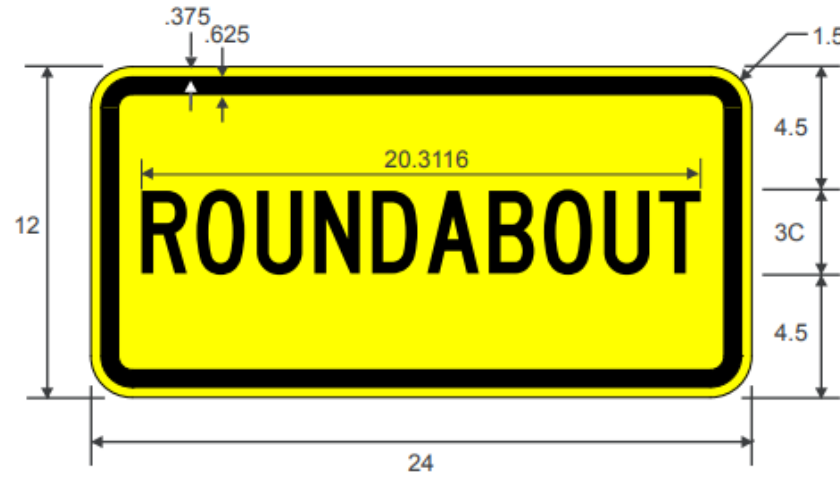

W2-6

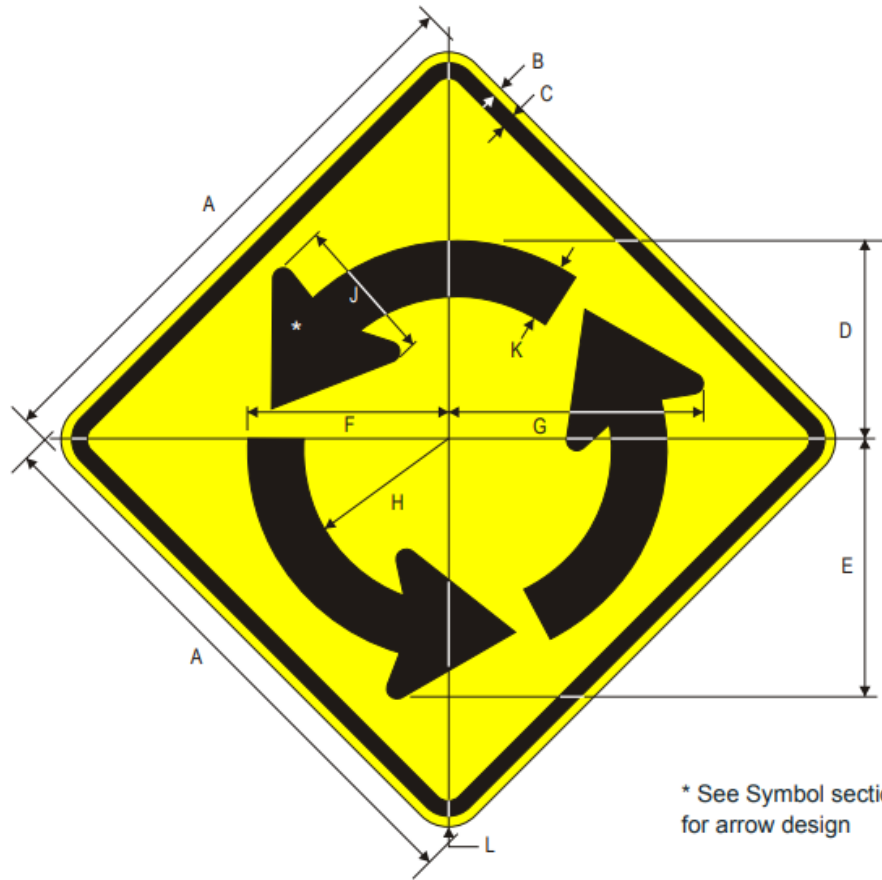

* See Symbol section for arrow design

A	B	C	D	E	F	G	H	J	K	L
24	.375	.625	8.406	10.808	8.406	10.848	6.028	6.18	2.378	1.5
30	.5	.75	10.487	13.490	10.487	13.570	7.549	7.725	2.938	1.875
36	.625	.875	12.569	16.172	12.569	16.292	9.043	9.27	3.526	2.25
48	.75	1.25	16.812	21.616	16.812	21.696	12.056	12.36	4.756	3

W2-6aT

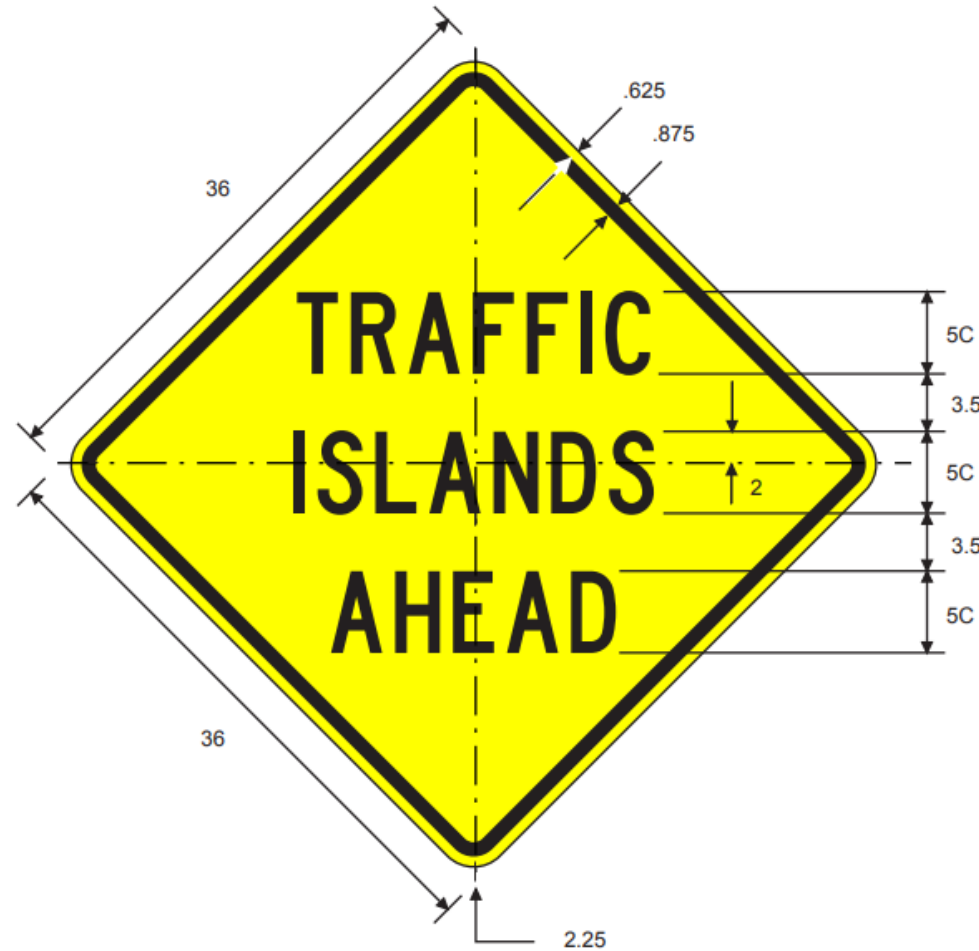

W16-12P

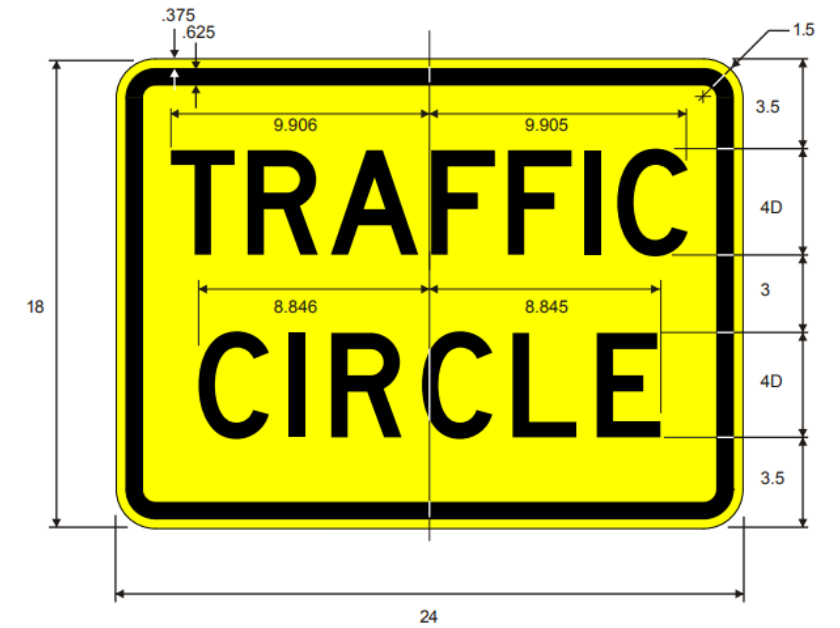

ALL DIMENSIONS ARE IN INCHES
IF THE DIMENSION HAS A LETTER SUFFIX,
IT INDICATES THE HIGHWAY FONT SERIES

CITY OF DALLAS DEPARTMENT OF TRANSPORTATION		
TRAFFIC SIGN DIMENSIONS		
APPROVED BY: GHASSAN KHANKARLI, P.E.	EFF DATE: June 2021	SHEET 21

SCHOOL FLASHERS - RAPID REFLECTIVE FLASHING BEACONS

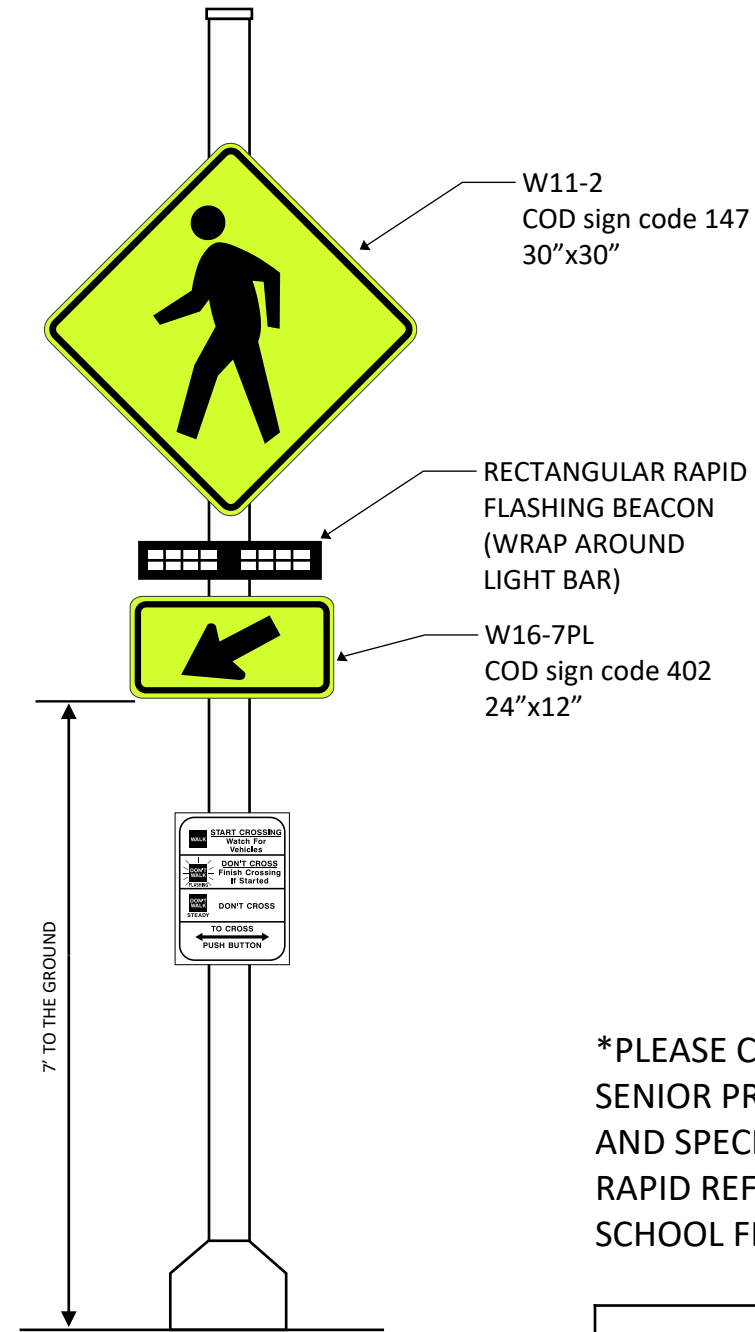
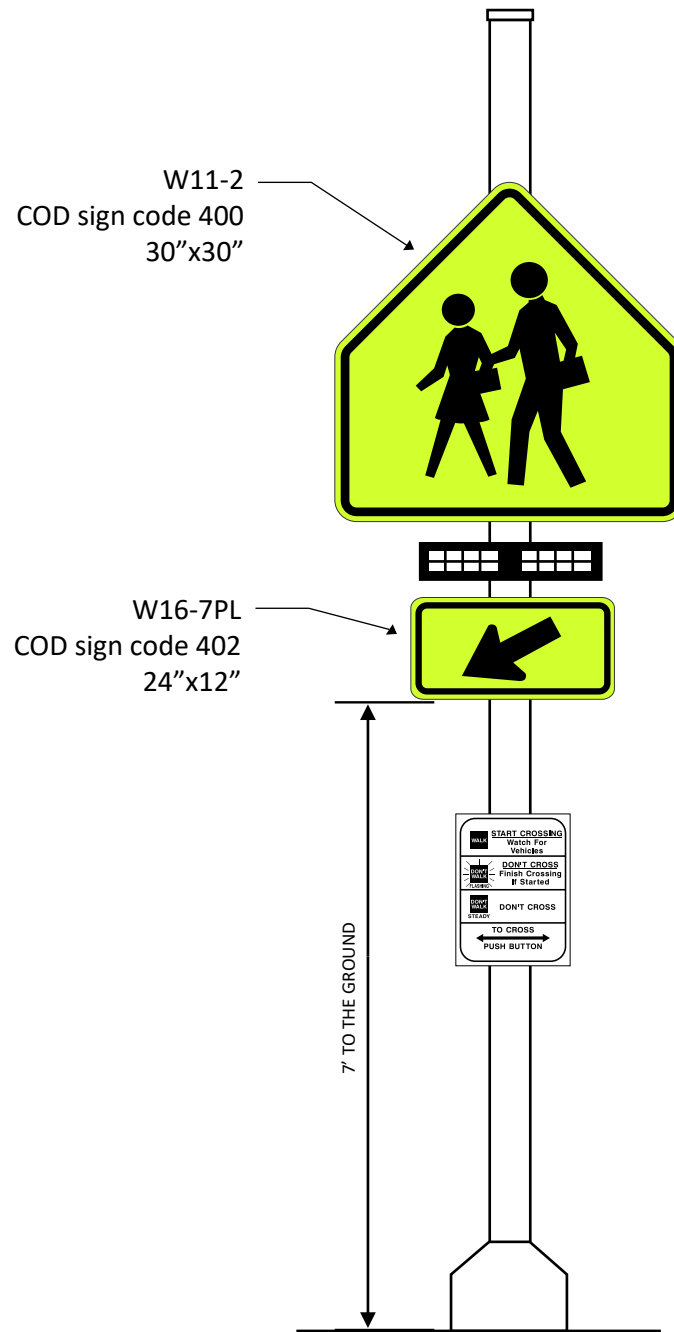
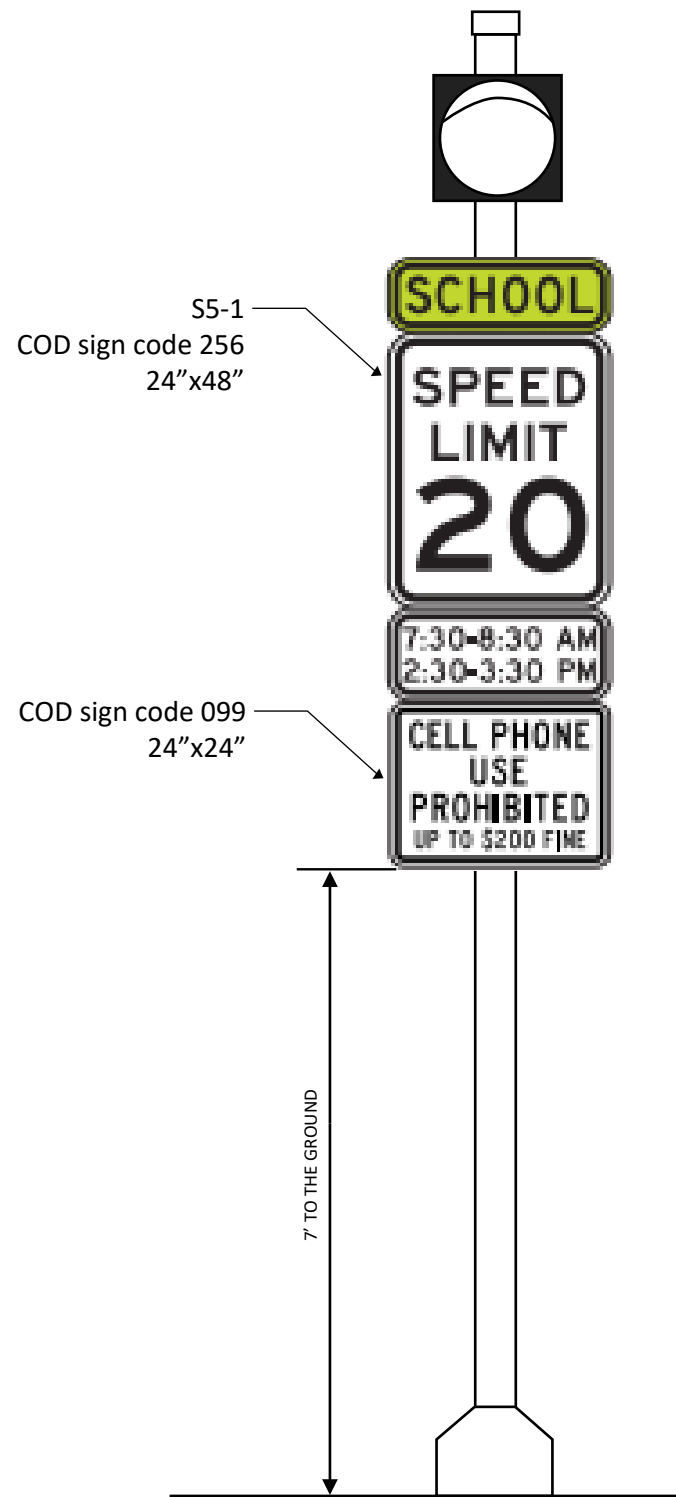

*INSTALL A 12" WHITE TRANSVERSE LINE ACROSS THE FULL PAVEMENT WIDTH TO MARK EACH END OF ESTABLISHED REDUCED SCHOOL SPEED LIMIT WITHIN THE SCHOOL ZONE IN ACCORDANCE WITH TMUTCD SECTION 7C.03

*PLEASE CONTACT THE TRAFFIC SIGNALS SENIOR PROGRAM MANAGER FOR STANDARDS AND SPECIFICATIONS FOR THE RAPID REFLECTIVE FLASHING BEACON AND SCHOOL FLASHER ASSEMBLY.

CITY OF DALLAS DEPARTMENT OF TRANSPORTATION		
SCHOOL FLASHER AND RRFB ASSEMBLY		
APPROVED BY: GHASSAN KHANKARLI, P.E.	EFF DATE: June 2021	SHEET 22